



16th World Conference on Applied Science,
Engineering and Technology
(WCASET – 19)



Dubai, UAE
21st-22nd February' 19

Institute For Engineering Research and Publication

India

www.iferp.in

Publisher: IFERP Explore

©Copyright 2019, IFERP-International Conference, Dubai

No part of this book can be reproduced in any form or by any means without prior written
Permission of the publisher.

This edition can be exported from India only by publisher

IFERP-Explore

Editorial:

We cordially invite you to attend the **16th World Conference on Applied Science, Engineering and Technology (WCASET - 19)** which will be held at **Flora Creek Deluxe Hotel Apartments, Dubai Creek - Dubai - United Arab Emirates** on **February 21st- 22nd, 2019**. The main objective of **WCASET** is to provide a platform for researchers, engineers, academicians as well as industrial professionals from all over the world to present their research results and development activities in relevant fields of Science, Engineering and Technology. This conference will provide opportunities for the delegates to exchange new ideas and experience face to face, to establish business or research relationship and to find global partners for future collaboration.

These proceedings collect the up-to-date, comprehensive and worldwide state-of-art knowledge on cutting edge development of academia as well as industries. All accepted papers were subjected to strict peer-reviewing by a panel of expert referees. The papers have been selected for these proceedings because of their quality and the relevance to the conference. We hope these proceedings will not only provide the readers a broad overview of the latest research results but also will provide the readers a valuable summary and reference in these fields.

The conference is supported by many universities, research institutes and colleges. Many professors played an important role in the successful holding of the conference, so we would like to take this opportunity to express our sincere gratitude and highest respects to them. They have worked very hard in reviewing papers and making valuable suggestions for the authors to improve their work. We also would like to express our gratitude to the external reviewers, for providing extra help in the review process, and to the authors for contributing their research result to the conference.

Since December 2018, the Organizing Committees have received more than 56 manuscript papers, and the papers cover all the aspects in Electronics, Computer Science, Information Technology, Science Engineering and Technology. Finally, after review, about 18 papers were included to the proceedings of **WCASET - 2019**.

We would like to extend our appreciation to all participants in the conference for their great contribution to the success of **WCASET 2019**. We would like to thank the keynote and individual speakers and all participating authors for their hard work and time. We also sincerely appreciate the work by the technical program committee and all reviewers, whose contributions made this conference possible. We would like to extend our thanks to all the referees for their constructive comments on all papers; especially, we would like to thank to organizing committee for their hard work.

Acknowledgement

IFERP is hosting the **16th World Conference on Applied Science, Engineering and Technology** this year in month of February. The main objective of WCASET is to grant the amazing opportunity to learn about groundbreaking developments in modern industry, talk through difficult workplace scenarios with peers who experience the same pain points, and experience enormous growth and development as a professional. There will be no shortage of continuous networking opportunities and informational sessions. The sessions serve as an excellent opportunity to soak up information from widely respected experts. Connecting with fellow professionals and sharing the success stories of your firm is an excellent way to build relations and become known as a thought leader.

I express my hearty gratitude to all my Colleagues, staffs, Professors, reviewers and members of organizing committee for their hearty and dedicated support to make this conference successful. I am also thankful to all our delegates for their pain staking effort to travel such a long distance to attend this conference.



A. Siddh Kumar Chhajjer
Director
Institute for Engineering Research and Publication (IFERP)

16th World Conference on Applied Science Engineering and Technology – 2019

Message from Key Note



I congratulate all the authors , Research scholars, members of the program committee , the external referees, Reviewers, organizers, members of editorial board with their opinion and expertise, Ensured a very high quality World Conference. I wish that the proceedings will serve as a useful reference for the scope of Research. I hope this “**16th - World Conference on Applied Science Engineering and Technology (WCASET - 19)**”, which will be held in Dubai, UAE on 22nd of February 2019 organized by esteemed renowned IFERP would be a remarkable bench mark event across the globe. Wishing you all the great success. Good Luck.

A handwritten signature in blue ink, appearing to read 'Chitra Kiran.N', with a long horizontal flourish extending to the right.

Dr.Chitra kiran.N

Professor & Head Dept of ECE

Alliance College of Engineering & Design,

ALLIANCE UNIVERSITY

Bangalore.

CONTENTS

SL.NO	TITLES AND AUTHORS	PAGE NO
1.	A Framework for Ann-Based Oder Sensing System: An Electronic Nose Approach ➤ <i>Yousif A. Latif Albastak</i>	1 – 6
2.	New Records of Bloodsucking Flies Associated with Wild Birds of Haftad-Gholleh Protected Area, Iran (Diptera: Hippoboscidae, Calliphoridae) ➤ <i>Araghi MP</i> ➤ <i>Gilasian E</i> ➤ <i>Samaie A</i>	7 – 11
3.	CO ² Purification using an Aqueous Amine Absorbent in the Syngas ➤ <i>Jeong Ho Choi</i> ➤ <i>Soung Hee Yun</i> ➤ <i>Yeo Il Yoon</i> ➤ <i>Jung-Hyun Lee</i>	12 – 17
4.	The Influence of Environment on the Delivery of Innovation in Construction Projects Considering the Mediation Effect of Project Managers’ Competences: A Literature Review and Research Framework ➤ <i>Dr. Afaf Hassan</i>	18 – 24
5.	Dynamic Modeling and Analysis of a Self Voltage Regulating Three Phase Self-Excited Induction Generator ➤ <i>M. Rizwan Khan</i> ➤ <i>M. Faisal Khan</i>	25 – 29
6.	Socio-Economic Determinants of Sweet Melon Production in Balanga Local Government Area of Gombe State, Nigeria ➤ <i>Omorogbe I</i> ➤ <i>Aina OS</i> ➤ <i>Yakubu SA</i> ➤ <i>Hassan AA</i>	30 – 35
7.	“Smart Dust” & Internet of Things (IoT): Progress & Challenges ➤ <i>Devendra K Sadana</i> ➤ <i>Ning Li</i> ➤ <i>Stephen W Bedell</i> ➤ <i>Ghavam S Shahidi</i>	36 – 38
8.	An Approach to Measure Similarity of Software Projects at the Design Phase ➤ <i>Asif imran</i>	39– 44
9.	Development of Real-Time 2.5 Dimensional Topographical Map for AR System of Excavators ➤ <i>Joo Hwan Park</i> ➤ <i>Do Hyoung Shin</i>	45 – 48
10.	Military Spying Robot ➤ <i>Sarmad Hameed</i> ➤ <i>Muhammad Hamza Khan</i> ➤ <i>Naqi Jafri</i> ➤ <i>Adeel Azfar Khan</i> ➤ <i>Muhammad Bilal Taak</i>	49 – 54

CONTENTS

SL.NO	TITLES AND AUTHORS	PAGE NO
11.	Design, Fabrication and Experimentation of Swing Electricity Power Generation System ➤ <i>Juntakan Taweekun</i> ➤ <i>Saba arif</i> ➤ <i>Mas Fawzi</i> ➤ <i>Nor Zelawati Binti Asmuin,</i> ➤ <i>Mohd Faizal Mohideen Batcha</i> ➤ <i>Zamri Noranai</i>	55 – 58
12.	Utilization Manufactured Sand as Fine Agregate for Concrete Quality ➤ <i>Ranti Hidayawanti</i> ➤ <i>Supriadi Legino</i> ➤ <i>Iriansyah Sangadji</i>	59 – 62
13.	Data Management for Interdisciplinary Mechatronic Systems ➤ <i>Hani Balkhair</i> ➤ <i>Clarence de Silva</i>	63– 66
14.	A survey investigation for the Corruption in Iraqi Construction Projects ➤ <i>Abdulnasser M. Abbas</i> ➤ <i>Haleem K. Hussain</i> ➤ <i>Ahmed Sagban Saadoon</i>	67 – 72
15.	Optimization of Parameters for Student Assessment Using Response Surface Methodology ➤ <i>Aruna M</i> ➤ <i>Rashmi Rani</i>	73 – 77
16.	Numerical Modeling of Flow over an Ogee Crested Spillway under Radial Gate: VOF and MMF Model ➤ <i>Date V</i> ➤ <i>Dey T</i> ➤ <i>Joshi S</i>	78– 82
17.	Commentary on Aeronautics and Aerospace Engineering ➤ <i>Lamar JE</i>	83
18.	Unconventional Gas Production from Hydraulically Fractured Well - A Application of Direct Search Based Optimization Algorithm ➤ <i>M.M. Rahman</i> ➤ <i>A. Suboyin</i> ➤ <i>M. Haroun</i>	84 - 93

ORGANIZING COMMITTEE

1. Dr. K. Debnath

Assistant Professor, Department of Mechanical Engineering, National Institute of Technology Meghalaya

2. Dr. P. Vidya Sagar

Associate Professor, Velgapudi Ramakrishna Siddhartha Engineering College

3. Dr. Umale Sudhakar Santoshrao

Associate Professor (CAS), Sardar Patel College of Engineering, Andheri, Mumbai

4. Jamal I. Daoud

Associate Professor, Department of Science in Engineering, Faculty of Engineering (IIUM), Kuala Lumpur, Malaysia

5. Dr. Moparthy Nageswara Rao

Associate Professor, Department of CSE, Velagapudi Ramakrishna Siddhartha Engineering College Vijayawada, Andhra Pradesh

6. Dr. Hamidi Abdul Aziz

Professor, Environmental Engineering Solid waste management/Landfill technology, Malaysia

7. Amjad Khabaz

Associate Professor, Faculty of Engineering, Hasan Kalyoncu University, Gaziantep, Turkey

8. G. Krishna Kishore

Associate Professor, Dept. of CSE, V.R. Siddhartha Engg. College, Vijayawada, Andhra Pradesh

9. Dr. Manvendra Vashistha

Professor and HOD, Dept. of Applied Mathematics, Sciences and Humanities, Pillai HOC College of Engineering and Technology, Rasayani, Raigad

10. Dr. P. S. Sheeba

Associate Professor & Head, Dept. of Electronics Engineering, Lokmanya Tilak College of Engineering, Navi Mumbai

11. Dr. Amjad Hameed Abdul Razaq Al-Modhafer

Assistant professor, Civil Engineer/ Structural Engineer, University of Kufa

12. Md Sazzad Hossien Chowdhury

Associate Professor, Department of Science in Engineering, Faculty of Engineering, International Islamic University Malaysia (IIUM)

13. Ali Naji Attiyah

Executive Director of ACI Iraq Chapter, Civil Engineering Department, College of Engineering, University of Kufa

14. Qasim M. Shakir

Assistant professor, Engineering-Civil , Dept University of Kufa

15. Mohammed Shaker Mahmood Al Shakerchy

Assistant professor, Civil Engineering Dept, University of Kufa

16. Dr. Nasr Hamood Mohamed Al-Hinai

Assistant professor, Faculty of Engineering, Sultan Qaboos University, Oman

17. Salman Nazari Shrikouhi

Supply Chain Management, University of Tehran

18. Hakan Gultekin

Associate Professor, Department of Mechanical & Industrial Engineering, Sultan Qaboos University, Muscat, Oman

A Framework for Ann-Based Oder Sensing System: An Electronic Nose Approach

^[1] Yousif A. Latif Albastak
Department of Computer Science
College of Information Technology
University of Bahrain

Abstract:-- Odor Sensing and electronic noses has formed into a vital part of our lives with numerous uses of it. From detecting food spoilage, to diagnosis of diseases, it has been developed and tested in various fields and industries for specific purposes. This research work proposes a machine learning based e-nose system that has been developed for detection of various types of odors for a general purpose. The system can be trained on any odor using various e-nose sensors of various types. Artificial Neural Network is employed as its Machine Learning algorithm along with an OMX-GR semiconductor gas sensor for collecting odor data. The system was trained and tested with three different types of odors collected through a standard data collection method and then purified which in turn had a result varying from 93% to 100% accuracy.

Index Terms: artificial neural network (ANN), electronic nose (e-nose), back propagation, OMX-GR sensor

I. INTRODUCTION

The headway of innovation in the previous couple of decades showed all methods for solace and openness. For example, the cell phones that we had once that used for voice communications are now changed to smart phones and the methods of interacting with a these devices using a traditional keyboard has now been complimented by touch, and even through voice commands.

These advances have had the specialists and researchers chip away at various ways and techniques to add more approaches to communicate with computers and by one means or another give it more "senses". This vision has prompted advancement of different sorts of sensors through which computers can interact with users and the environment around them. Improvements have been made in the fields of different sorts of connections, for example, touch/pressure, measuring temperature and notwithstanding giving computers a "vision" through cameras and image recognition. These developments and advancements have enabled different applications in many industries.

One of these "senses" has been empowering the computer to "smell" or distinguish odors. Envision being on a video call with a companion over another country and having the capacity to smell what perfume they are wearing. Or, then again being able to not just take pictures and keep them as recollections yet additionally smell the places and events.

Or, on the other hand strolling through a Virtual world with a capacity to recognize what it smells like.

The endeavors of researchers in this field led to development of an odor-sensing electronic nose first introduced in 1982 [1] which utilized a multi-sensor array of gas sensors combined to classify odors by the detection of different gases present. Since then until now over a period of over three decades, much advancement have been made in the hardware technology of electronic noses with more sensors being introduced and many being created for very specific purposes such as detection of leakage in natural gas factories, analyzing amount of carbon dioxide in an environment. Though less as compared to special purpose sensors, there have been developments in general purpose sensors consisting of a wider array of different types of sensors as well.

Human's sense of smell was utilized in food factories and many other industries to differentiate spoiled from unspoiled food and in other applications. This approach can be unreliable at times due to the limitations of the range of odors a human nose can detect. An alternate that is used are dogs but the cost of their training is high and they have a short life span.

As humans, our sense of smell is very important and we rely on it for various tasks and functions some of which are daily activities and others which can be more important. Despite the importance of this sense, our sense of smell is usually limited both in its capabilities and can be

influenced by external factors such as flu, our surroundings and other factors. Our human sense of smell can also only detect a limited number of gases due to which must be facilitated by adding compounds to different gases for humans to be able to detect it [2].

These limitations of human olfactory system make it difficult to rely on humans for the job of odor detection in Industries. Moreover, the odor detection of dangerous gases, even though possible by humans, may be fatal. An alternate approach is to train and utilize dog for odor sensing. This too has limitations as it is expensive to train dogs, and their life span is short and limited. These limitations have led to the development of electronic noses which try to mimic the human olfactory system. Electronic noses have proved their significance in various fields of health and industries and have been used as sensors for detection of food spoilage and in diagnosis of various diseases and much more [2]. Despite advances in the hardware of electronic noses, there hasn't been much attention paid to the software side of electronic noses.

This research aims to develop a general purpose Artificial Neural Network that can be used in various kinds of application from differentiating between markers, detecting food spoilage and diagnosing diseases.

II. MODELS OF THE OLFACTORY SYSTEM

The objective of a great part of the examination with respect to the olfactory framework is to see how singular smells are recognized. Numerous analysts have created numerical models of the olfactory framework. These models regularly incorporate recreations of the neurobiological data preparing frameworks (biological neural networks). The olfactory data is handled in both the olfactory bulb and in the olfactory cortex. Figure 1 demonstrates the fundamental data preparing structures inside the brain. The olfactory cortex performs design grouping and acknowledgment of the detected smells. Once recognized, scent data is transmitted to the hippocampus, limbic framework and the cerebral cortex. The connection to the hippocampus explains why odor can sub-consciously evoke memories. Conscious perception of the odor and how to act on the odor takes place in the cerebral cortex [2]. The mammalian olfactory system uses a variety of chemical sensors, known as olfactory receptors, combined with signal processing in the olfactory bulb and automated pattern recognition in the olfactory cortex of the brain.

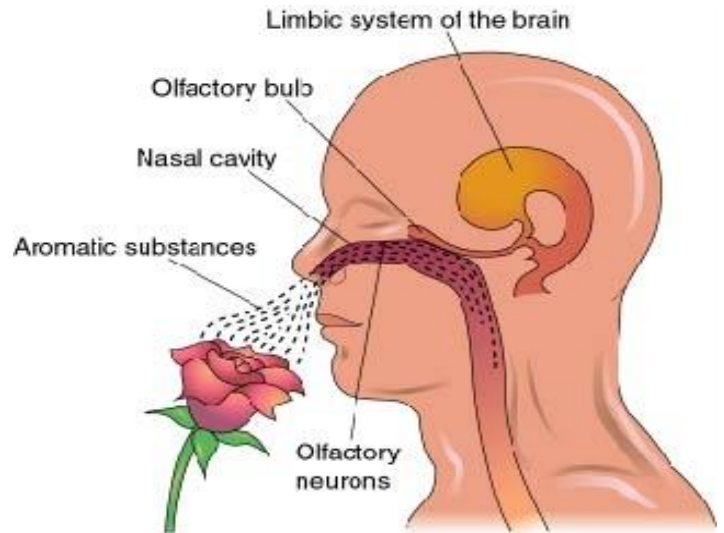

Figure 1: The major processes of the olfactory system

III. ELECTRONIC NOSES

Electronic noses [3], [4] and [5], are being created as frameworks for the automated recognition and characterization of smells, vapours and gasses. The two principle parts of an electronic nose are the odor detection framework and the computerized pattern recognition framework. The odor detection framework can be an array of several different sensing elements (e.g., chemical sensors), where each element measures a different property of the sensed odor, or it can be a single sensing device (e.g., spectrometer) that produces an array of measurements for each odor, or it can be a combination of both chemical sensors and a spectrometer. By showing a wide range of smells to the sensor array, a database of signatures is developed. This database of marked odor signatures is utilized to train the pattern recognition system. The objective of this preparation procedure is to arrange and configure the recognition system to deliver extraordinary mappings of every odor so that an automated distinguishing proof can be executed [6]. Albeit every sensor is intended for a particular chemical, each reacts to a wide assortment of chemical vapours. , On the whole these sensors react with one of a kind signature to various chemicals. Amid the preparation procedure, different chemicals with known blends are exhibited to the system.

IV. ARTIFICIAL NEURAL NETWORKS AND ELECTRONIC NOSES

ANNs are widely used to utilize and examine different data representation methods such as complex data and pattern recognition. These techniques are indicating promising outcomes in chemical vapor recognition. Figure 2 illustrates an electronic nose prototype with the help ANN to identify odors from several common chemicals.

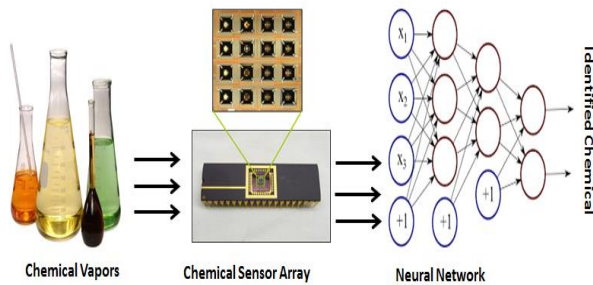

Figure 2: Electronic nose Prototype Using ANN

V. RELATED WORK

Reviewing related works in the field of electronic nose and its use in odor sensing shows that various smell sensors have been used for the different purposes alongside different methods of analysis which were mainly statistical in nature and not artificially intelligent. Moreover, the trend of using custom smell sensors is also seen, with many being developed for very specific purposes to detect specific odors only. An overview of this is given in the following paragraphs.

Research Paper: Lung cancer identification by the analysis of breath by means of an array of non-selective gas sensors [7]. **Smell Sensor Used:**LibraNose. **Method/Algorithm for Odor Sensing:** Partial Least Squares Discriminant Analysis. **Accuracy:**94%.

Research Paper:Use of an electronic nose to diagnose bacterial sinusitis [8]. **Smell Sensor Used:**Cyranose 320. **Method/Algorithm for Odor Sensing:**Support Vector Machine. **Accuracy:** 74%

Research Paper:Predicting Type 2 diabetes using an electronic nose-based artificial neural network analysis [9]. **Smell Sensor Used:**Custom Smell Sensor. **Method/Algorithm for Odor Sensing:**Artificial Neural Network. **Accuracy:** 92%.

Research Paper:Detecting quality of indoor-air using electronic nose [10] . **Smell Sensor Used:**Custom Smell Sensor. **Method/Algorithm for Odor Sensing:**Fuzzy Logic Pattern Recognition. **Accuracy:**90%-100%.

Research Paper:Application of ANN with extracted parameters from an electronic nose in cigarette brand identification [11]. **Smell Sensor Used:**Cyranose 320. **Method/Algorithm for Odor Sensing:**Artificial Neural Network. **Accuracy:**80-100%

Research Paper:An electronic nose system to diagnose illness [12]. **Smell Sensor Used:**Fox 2000.

Method/Algorithm for Odor Sensing:Statistical Analysis. **Accuracy:**80.6%.

Research Paper:An investigation on electronic nose diagnosis of lung cancer. Lung Cancer [13]. **Smell Sensor Used:**Custom Smell Sensor. **Method/Algorithm for Odor Sensing:**Partial Least Squares Discriminant Analysis. **Accuracy:**85.7%.

Research Paper:Electronic nose prediction of a clinical pneumonia score: biosensors and microbes[14]. **Smell Sensor Used:**Custom Smell Sensor. **Method/Algorithm for Odor Sensing:**Statistical Analysis. **Accuracy:** less than 50%.

Reviewing the aforementioned researches, this research uses a general-purpose sensor in form of OMX-GR and Artificial Neural Network for analysis due to its ability of being trained and being general purpose.

VI. DATA SAMPLING

A handheld OMX-GR odometer sensor (Figure 3) is used in this research study to collect data samples for three different materials: White Board Marker, Muscle Cream and Herbal Inhalant (these materials are used because of their strong smell). The sensor includes two semiconductor gas sensor with the capability to detect a variety of odors from combustible gases. This sensor measures odor with different strength and classifications. The odor strength range from 0 to 999 and a classification feature range from 0 to 89. Additionally the sensor supports two types of sampling measurement modes: real-time sampling and memory samplings.



Figure 3: OMX-GR Odometer Sensor and the Materials used for Data Sampling

During this phase of the research work we measured approximately 1800 data representing the odor classification and strength of three different materials. For each material 15 data samples are collected in an interval of 20 seconds each. Table 1 describes a sample of data collected for each material representing the odor classification and strength of the material.

White Board Marker	Muscle Cream	Herbal Inhalant
88,564	65,143	69,528
88,574	65,142	69,528
88,585	65,142	69,528
89,585	65,142	69,528
89,595	65,142	69,528
89,595	65,142	69,528
89,595	65,142	69,527
89,595	65,142	69,527
89,585	65,142	69,527
89,585	65,142	69,527

Table 1: Sample data representing the classification and strength of odors measured

Table 2 describes the range of the classification and strength of the entire data collected.

White Board Marker			Muscle Cream		Herbal Inhalant	
Sample #	Class	Strength	Class	Strength	Class	Strength
1	89-89	889-906	65-66	138-152	71-72	481-502
2	89-89	857-906	64-65	138-152	71-71	502-522
3	89-89	826-873	64-66	143-157	70-71	522-524
4	88-88	640-769	65-66	147-157	69-70	525-526
5	88-88	650-694	65-66	138-147	69-69	526-527
6	87-88	592-650	65-65	138-142	69-69	526-527
7	88-89	564-595	64-65	148-162	68-69	510-523
8	88-89	535-574	65-65	162-163	68-68	510-511
9	88-88	508-544	65-65	157-162	68-68	510-511
10	88-88	446-476	65-66	162-167	68-68	511-511
11	87-88	412-446	65-66	162-167	68-68	511-511
12	86-87	387-412	64-65	152-162	68-68	511-511
13	88-89	703-729	64-65	148-162	68-68	511-511
14	88-89	611-691	65-66	162-167	67-68	493-512
15	88-88	553-611	65-66	158-167	67-68	493-494
All Data	86-89	387-906	64-66	138-167	67-72	481-528

Table 2: The range of the measured odor classification and strength

In the second phase of the data collection process, all of the 15 samples of the data for the three materials were graphed to identify the similarities and the overlapping of

the samples before feeding it to the ANN. These similarities and overlapping is illustrated in Figure 4.

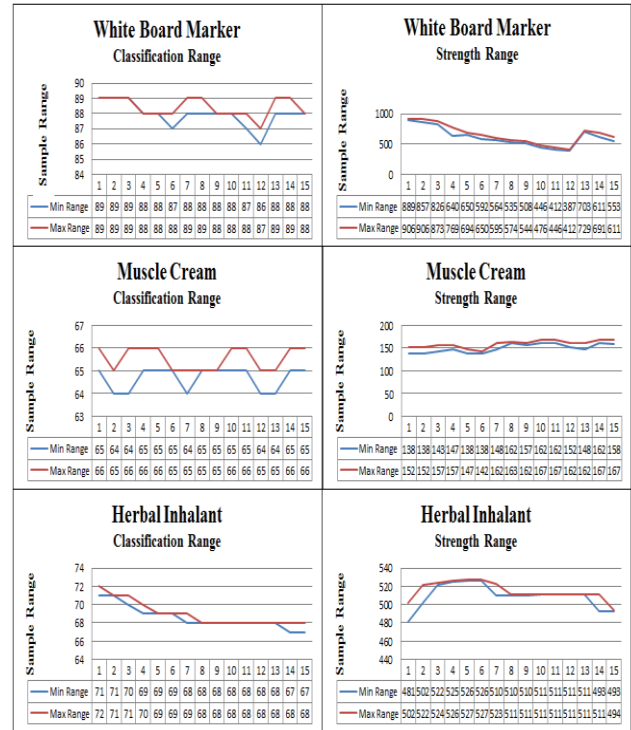

Figure 4: Similarities and overlapping of the odor data samples for each material

VII. METHODOLOGY AND RESULTS

The two main components of an electronic nose are the sensing system and the automated pattern recognition system. In this research study, the sensing system is a pair of semiconductor gas sensor to classify odors. This is a popular simplified handheld OMX-GR odor meter used as a tool for odor analysis to enable the indication of relative strength and odor classification numerically by comparing odor gases and purified air. The sensor produced an array of measurements for three different materials (White Board Marker, Muscle Cream and Herbal Inhalant). Each material vapor presented to the sensor array produced a signature or pattern characteristic of the vapor as shown in table 1. To generalize the ANN, the data is divided into three sets: training set 50%, validation set 25% and testing set 25%.

A backpropagation supervised learning technique is used and resulted with 0.0999 training error, 0.05312 validations and 0% testing. A total of 3178 epoch was used. Figure 6 shows the setup to use sigmoid function as a nonlinear with S shape curved function. The figure then illustrates the training graph and main results generated after feeding the data to the ANN program.

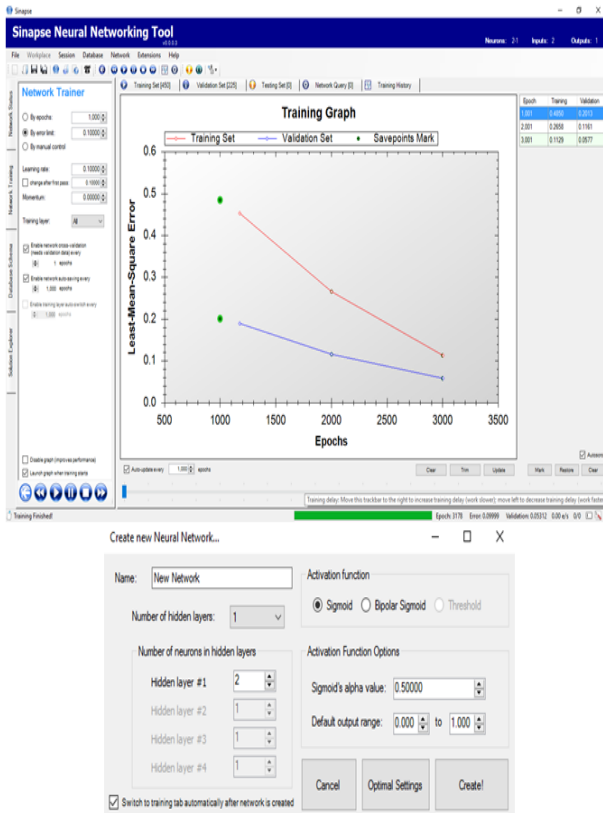

Figure 6: Setups and Results

VIII. CONCLUSION

Over past decades, the e-nose has significantly developed, despite the tendency to ignore the sense of smell in the artificial intelligence techniques. This study proposed a system with an e-nose combined with the ANN, which is considered the core of the system, to process and analyze the data and obtain a recognition pattern in order to obtain the best results similar to the human nose function. Although it is true that analyzing what has been learned by an artificial neural network is difficult, it is much easier to do so than to analyze what has been learned by a biological neural network. Furthermore, our research is exploring learning algorithms for neural networks which are gradually uncovering generic principles which allow a learning machine to be successful. The supervised learning used back propagation, and the best architecture of the ANN was determined to be a 2:6:1 ratio with a 1.72729 training error, 0.77849 validations, and 0.03% testing. The proposed system achieved very high performance and a low amount of error, with a high efficiency. Additionally, it acquired low cost tools to achieve the entire system.

REFERENCES

[1] Moran, T. (1982) "The fine structure of the olfactory mucosa in man". *Journal of Neurocytology*, 11(5), pp. 721-746.

[2] Li, Z. and J.J. Hopfield, (1989) "Modeling the olfactory bulb and its neural oscillatory processing". *Biol. Cybernet.*, 61: 379-392. DOI: 10.1007/BF00200803.

[3] Wilson, Alphas Dan. (2012). "Review of Electronic-nose Technologies and Algorithms to Detect Hazardous Chemicals in the Environment" In *First World Conference on Innovation and Computer Sciences (INSODE 2011)*, *Procedia Technology*:453-463 DOI: 10.1016/j.protcy.2012.02.101, Database: ScienceDirect

[4] Bikov, A.; La'za' r, Z.; Horvath, I. (2015) "Established methodological issues in **electronicnose** research: how far are we from using these instruments in clinical settings of breath analysis?". *Journal of Breath Research*, Sept. 2015, vol.9, no.3, 034001 (18 pp.).

[5] Kea-Tiong Tang; Shih-Wen Chiu. (2013) "Towards a Chemiresistive Sensor-Integrated **ElectronicNose: AReview**". *Sensors*, Vol 13, Iss 10, Pp 14214-14247 (2013); MDPI AG, 2013.

[6] Keller, P.E. R.T. Kouzes and L.J. Kangas, (1994). "Three neural network based sensor systems for environmental monitoring". *Proceeding of the IEEE Electro 94 Conference on Combined Volumes*, May 10-12, IEEE Xipore Press, Boston, MA., pp: 377-382. DOI: 10.1109/ELECTR.1994.472686

[7] Di Natale, C., Macagnano, A., Martinelli, E., Paolesse, R., D'Arcangelo, G., Roscioni, C., & D'Amico, A. (2003) Lung cancer identification by the analysis of breath by means of an array of non-selective gas sensors. *Biosensors and Bioelectronics*, 18(10), pp. 1209-1218.

[8] Thaler, E. R., & Hanson, C. W. (2006) Use of an electronic nose to diagnose bacterial sinusitis. *American journal of rhinology*, 20(2), pp. 170-172.

[9] Mohamed, E. I., Linder, R., Perriello, G., Di Daniele, N., Pöpl, S. J., & De Lorenzo, A. (2002) Predicting Type 2 diabetes using an electronic nose-based artificial neural network analysis. *Diabetes, nutrition & metabolism*, 15(4), pp. 215-221.

[10] Pearce, T. C., Schiffman, S. S., Nagle, H. T., & Gardner, J. W. (Eds.). (2006) *Handbook of machine olfaction: electronic nose technology*. John Wiley & Sons.

[11] Luo, D., Hosseini, H. G., & Stewart, J. R. (2004) Application of ANN with extracted parameters from an electronic nose in cigarette brand identification. *Sensors and Actuators B: Chemical*, 99(2), pp. 253-257.

[12] Gardner, J. W., Shin, H. W., & Hines, E. L. (2000) An electronic nose system to diagnose illness. *Sensors and Actuators B: Chemical*, 70(1), pp. 19-24.

[13] D'Amico, A., Pennazza, G., Santonico, M., Martinelli, E., Roscioni, C., Galluccio, G., & Di Natale, C. (2010) An investigation on electronic nose diagnosis of lung cancer. *Lung Cancer*, 68(2), pp. 170-176.

[14] Hanson, C. W., & Thaler, E. R. (2005) Electronic nose prediction of a clinical pneumonia score: biosensors and microbes. *The Journal of the American Society of Anesthesiologists*, 102(1), pp. 63-68.

New Records of Bloodsucking Flies Associated with Wild Birds of Haftad-Gholleh Protected Area, Iran (Diptera: Hippoboscidae, Calliphoridae)

^[1] Araghi MP, ^[2] Gilasian E, ^[3] Samaie A

^[1] Insect Taxonomy Research Department, Iranian Research Institute of Plant Protection, Agricultural Research, Education and Extension Organization (AREEO), Tehran, Iran

^[2] Department of Environment of Markazi province, Arak, Iran

Abstract— We have studied the parasitic flies of wildlife of Haftad-Gholleh Protected Area, Iran, for the first time and report here the three hematophagous fly species of birds: the louse fly *Ornithophila metallica* (Schiner) (Hippoboscidae), and bird nest flies *Trypocalliphora braueri* (Hendel) and *Protocalliphora azurea* (Fallen) (Calliphoridae). The genera and species *O. metallica* and *T. braueri* are new to Iran

Keywords: Avian myiasis; Louse flies; *Ornithophila metallica*; *Trypocalliphora braueri*; *Protocalliphora azurea*; Blow flies

I. INTRODUCTION

Avian myiasis-causing flies and bird's blood-feeding ectoparasite flies mainly belong in the family's Calliphoridae and Hippoboscidae. The family Hippoboscidae, commonly known as louse flies, consists of 213 hematophagous species of birds and mammals worldwide [1]. This family is known in Iran only by the single species *Pseudolynchia canariensis* (Macquart), pigeon fly that has been repeatedly recorded from various cities across the country [2-5]. Aside from being a nuisance to their hosts, hippoboscids are capable transmitters of pathogenic and parasitic agents, including avian trypanosomes and mammals' bacteria, causing serious diseases in wild birds [6] and ruminant animals [7,8]. They are also the only known vectors of apicomplexan parasites of the genus *Haemoproteus* to birds and transmitters of filarial nematodes to domestic and wild mammals [9,10].

The majority of myiasis-inducing species belong to the family Calliphoridae, esp. subfamily Chrysomyinae, whose members are known as important facultative and obligatory parasites. Bird myiasis records are not as frequent as mammals' most likely due to the inaccessibility of the hosts. With respect to Iran, the reports of avian myiasis have been poorly documented [11,12], mainly because of difficulties in larval identification. Although the said technical problem often necessitates the rearing of the maggots for a reliable identification at adult stage, in a recent case of avian wound myiasis in southwestern Iran the myiatic agent was successfully identified at larval stage [13]. The genera *Protocalliphora* Hough and *Trypocalliphora* Peus contain

specialist bird nest parasites whose larvae feed on the blood of nestling birds through tunneling under their skin, causing a type of myiasis called subcutaneous myiasis, and eventually leading to heavy damages to the tissues or death of young birds [14]. The species *P. azurea* (Fallen) is widely spread in the Palearctic region and remains the only species of birds' subcutaneous myiasis agents that has been recorded from Iran so far [15].

II. MATERIAL AND METHODS

Haftad-Gholleh Protected Area covers an estimated area of 97,400 hectares (240,680 acres) and is home to a large number of vulnerable mammal and bird species (Figure 1). Using Malaise traps, the specimens were collected in 75% ethyl alcohol and preserved at the Hayk Mirzayans Insect Museum (HMIM), Tehran, Iran. In case of the examination of male genitalia, we detached the whole abdomen to clear it in hot 10% KOH and then washed it lightly in glacial acetic acid



Figure 1: A general view of Chekab valley, Haftad-Gholleh protected area, Iran.

to remove the base. After dissecting the male genitalia, the abdomen was glued back to its original place and the genitalia transferred to a microvial and pinned below the associate specimen. Specimen data: 1♂ 1♀ *Ornithophila metallica*; 2♂♂ 3♀♀ *Protocalliphora azurea*; 1♀ *Trypocalliphora braueri*; Iran: Markazi province, Amr-abad village, Haftad-Gholleh Protected Area, Chekab valley, 2219 m, 34°07'05.3"N 050°16'25.3"E, 28 May-15 June, 2016, Malaise trap near pool, E. Gilasian & M. Parchami-Araghi. Birds of haftad-gholleh protected area Haftad-Gholleh is home to an estimated 71 species within 26 families of wild birds and serves as a sanctuary for a number of migrating birds as well. We have listed the following common avian taxa of this area to underline the impact of hematophagous flies on the bird fauna: *Monticola solitarius* (L.) (blue rock thrush), *Accipiter* spp. (hawks), *Falco* spp. (falcons and kestrels), *Coturnix* spp. (quails), *Columba* spp. (pigeons), *Cuculus* spp. (cuckoos), *Coracias* spp. (rollers), *Merops* spp. (bee-eaters), *Upupa* spp. (hoopoes), *Galerida* spp. (larks), *Hirundo* spp. (passerines), *Muscicapa striata* (Pallas) (spotted flycatcher), *Emberiza melanocephala* Scopoli (black-headed bunting), *E. cia* (L.) (rock bunting), *E. citrinella* L. (yellowhammer), *Turdus* spp. (true thrushes), *Motacilla* spp. (wagtails), *Lanius* spp. (typical shrikes), *Parus* spp. (tits), *Passer* spp. (sparrows.), *Sturnus* spp. (starlings), *Corvus* spp. (crows), *Pica pica* (L.) (Eurasian magpie), *Ammoperdix* spp. (partridges), *Gypaetus* spp. (vultures), *Aquila* spp. (eagles), *Athene noctua* (Scopoli) (little owl), swifts (Apodidae) and woodpeckers (Picidae) [16].

III. RESULTS AND DISCUSSION

We, for the first time, collected three species of bloodsucking flies from Haftad-Gholleh Protected Area where strictly feed on wild birds. The recorded fly species are as follows: *Ornithophila metallica* (Schiner), *Protocalliphora azurea* (Fallen) and *Trypocalliphora braueri* (Hendel). Both *O. metallica* and *T. braueri* are new genus and species records for the Iranian fauna.

Ornithophila metallica (Schiner)

Both sexes of the hippoboscid *O. metallica* are hematophagous ectoparasites and ingest blood from a wide variety of birds (Figures 2 and 3). Maa [17] listed the host birds for the two Palearctic members of *Ornithophila* Rondani, *O. metallica* and *O. gestroi* Rondani, and categorized the former as a species with "having high population density and very wide host and distributional ranges" and found the latter to be a species with "low population density and much more restricted host/ or

distributional ranges." *O. metallica* is widely distributed in the Old World including Iran's neighboring countries of Pakistan, Afghanistan and Turkey (Figures 4-10) [17]. These species are commonly known as bird blow flies or bird nest flies. *Trypocalliphora* is a monotypic genus, with a single Holarctic



Figure 2: *Ornithophila metallica* (Schiner): Dorsal view.



Figure 3: *Ornithophila metallica* (Schiner): Lateral view.

species *T. braueri* which differs from its closest related genus *Protocalliphora* in having additional notopleural setae. Although some Dipterists consider *Trypocalliphora* a subgenus within *Protocalliphora* [18], other calliphorid taxonomists argued that *Trypocalliphora* is to be considered as a valid genus [19-21]. These species display different types of parasitic strategies as the larvae of *P. azurea* feed on the blood of young birds of the order Coraciiformes and remain on the surface of the birds, but the hematophagous larvae of *T. braueri* infest nestlings of the order Falconiformes and burrow beneath the skin of their hosts, causing a form of parasitism called subcutaneous myiasis [18].



Figure 4: *Protocalliphora azurea* (Fallen): Dorsal view



Figure 5: *Protocalliphora azurea* (Fallen): Lateral view.



Figure 6: *Protocalliphora azurea* (Fallen): Male genitalia, lateral view



Figure 7: *Protocalliphora azurea* (Fallen): Male genitalia, posterior view.

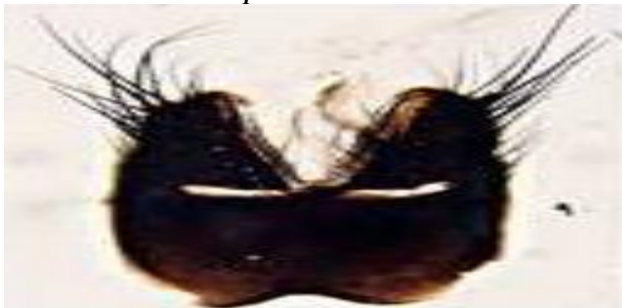

Figure 8: *Protocalliphora azurea* (Fallen): Male sternite



Figure 10: *Trypocalliphora braueri* (Hendel): Lateral view

IV. CONCLUSION

Haftad-Gholleh Protected Area, like most of Iranian natural habitats, has been experiencing destructive interventions from illegal human activities, including poaching, that aggravating the vulnerability of its wildlife to epidemics and parasites as an ovine rinderpest epidemic heavily emaciated the population of wild goats of this area in 2015. In terms of birds, the sprawling build-up areas, power lines and transmission towers pose significant threats to migrating birds of the area and nearby parks. In a framework of a faunistic project, we are working to document the insect diversity of Haftad-Gholleh Protected Area to underscore the need for improving the conservation measures and policies towards a standard protection of the area and its fauna and flora.

V. ACKNOWLEDGEMENTS

We wish to thank Dr Nil Rahola (Université de Montpellier, Montpellier, France) for confirming the identity of *Ornithophila metallica*. We are also grateful to the Department of Environment of Markazi province and the rangers at Haftad-Gholleh Protected Area for facilitating our research through the area.

REFERENCES

1. Dick CW (2006) Checklist of world Hippoboscidae (Diptera: Hippoboscoidea). Department of Zoology, Field Museum of Natural History, Chicago p: 7.
2. Borji H, Moghaddas E, Razmi GR, Azad M (2012) A survey of ecto-and endoparasites of domestic pigeons (*Columba livia*) in Mashhad, Iran. *Iran J Vet Sci Technol* 4: 37-42.
3. Radfar MH, Fathi S, Norouzi AE, Mirzaei DM, Rezaei SH (2011) A survey of parasites of domestic pigeons (*Columba livia domestica*) in South Khorasan, Iran. *Vet Res* 4: 18-23.
4. Pirali KK, Dehghani SA, Ahmadi BN, Najafzadeh V (2016) A First report of infestation by *Pseudolynchia canariensis* in a herd of pigeons in Shahrekord (Southwest of Iran). *J Arthropod-Borne Dis* 10: 426-430.
5. Khoobdel M, Akhoond MR (2015) The survey on *Pseudolynchia canariensis* (Diptera: Hippoboscidae) in military sites and human bite cases reported in Tehran, Iran. *J Milit Med* 16: 243-251.
6. Kucera J (1983) Incidence and some ecological aspects of avian trypanosomes in Czechoslovakia. *Folia Parasitol* 30: 209-222.
7. Halos L, Jamal T, Maillard R, Girard B, Guillot J, et al. (2004) Role of Hippoboscidae flies as potential vectors of *Bartonella* spp. infecting wild and domestic ruminants. *Appl Environ Microbiol* 70: 6302-6305.
8. Reeves WK, Nelder MP, Cobb KD, Dasch GA (2006) *Bartonella* spp. in deer keds, *Lipoptena mazamae* (Diptera: Hippoboscidae), from Georgia and South Carolina, USA. *J Wildlife Dis* 42: 391-396.
9. Nelson GS (1963) *Dipetalonema dracunculoides* (Cobbold, 1870), from the dog in Kenya: with a note on its development in the lousefly, *Hippobosca longipennis*. *J Helminthol* 37: 235-240.
10. Daynes P (1964) Note sur les helminthoses des animaux domestiques reconnues à Madagascar. *Revue d'Élevage et de Médecine Vétérinaire des Pays Tropicaux* 17: 477-490.
11. Halajian A, Tavakol S, Mansoori J (2012) The first report of pigeon maggot, *Protocalliphora* sp. (Diptera: Calliphoridae) from domestic pigeons in Iran. *Comp Clin Pathol* 21: 361-362.
12. Pirali KK, Cheraghchi BM, Navidpour S (2010) Infestation of an owl (*Bubo bubo*) with *Lucilia* spp. *Comp Clin Pathol* 19: 221-2214.
13. Parchami AM, Eskandari F, Gilasian E (2015) Avian wound myiasis caused by *Calliphora vicina* Robineau Desvoidy (Diptera: Calliphoridae) in an immature migrating Eastern Imperial Eagle (*Aquila heliaca* Savigny) (Aves: Accipitridae) in southwestern Iran. *Vet Sci Technol* 6.
14. Little SE (2009) Myiasis in wild birds. *Parasitic Diseases of Wild Birds*. In: Atkinson CT, Thomas NJ, Hunter DB (ed.) Wiley-Blackwell, Oxford pp: 546-556.
15. Parchami AM, Peris SV, Gonzalez MD (2001) New records of Iranian Calliphoridae and Sarcophagidae, with a guide to the males of Palaearctic *Protocalliphora* (Diptera, Calyptratae). *Boletín de la Real Sociedad Española de Historia Natural (Sección Biológica)* 96: 175-181.
16. (2003) Reports of wildlife of Hafta-Gholleh Protected Area.
17. Maa TC (1969) Synapses of the genera *Ornithophila* and *Ornithoctona* with remarks on their habitat diversification (Diptera: Hippoboscidae). *Pacific Insects Monograph* 20: 1-23.
18. Sabrosky CW, Bennett GF, Whitworth TL (1989) Bird blow flies (*Protocalliphora*) in North America (Diptera: Calliphoridae) with notes on the Palearctic species. Smithsonian Institution, Washington, DC, USA.
19. Rognes K (1985) Revision of the bird-parasitic blowfly genus *Trypocalliphora* Peus, 1960 (Diptera: Calliphoridae). *Entomologica Scandinavica* 15: 371-382.
20. Whitworth TL (2003) A key to the puparia of 27 species of North American *Protocalliphora* Hough (Diptera: Calliphoridae) from bird nests and two new puparial descriptions. *Proc Entomol Soc Wash* 105: 995-1033.
21. Whitworth TL (2006) Key to the genera and species of blow flies (Diptera: Calliphoridae) of America north of Mexico. *Proc Entomol Soc Wash* 108: 689-725.

CO₂ Purification using an Aqueous Amine Absorbent in the Syngas

^[1] Jeong Ho Choi, ^[2] Soung Hee Yun, ^[3] Yeo Il Yoon, ^[4] Jung-Hyun Lee

^{[1][2][3]} Greenhouse Gas Laboratory, Climate Change Research Division, Korea Institute of Energy Research, 152 Gajeong-ro, Yuseong-gu, Daejeon 34129, Korea

^{[1][4]} Department of Chemical & Biological Engineering, Korea University, 145 Anam-dong, Seongbuk-gu, Seoul 02841, Korea

Abstract: -- The acetic acid production using syngas in the BP chemical process showed superior performance compared to using rhodium-based catalyst. However, CO₂ in the syngas causes poison of the promoted-iridium and the performance of the catalyst degrades. Therefore, CO₂ must remain at extremely low concentration below 20 ppmv. In this study, we try to develop the new CO₂ capturing absorbent for replacing with BASF a-MDEA (activated MDEA). The absorption performance of amine absorbents was evaluated to keep the CO₂ concentration low and the applicability of the absorbent for acetic acid production process was evaluated. A continuously stirred-tank reactor and differential reaction calorimeter were used to measure the CO₂ absorption capacity and heat of reaction, respectively. As results among the amine absorbents, KIERSOL-N and KIERSOL-P showed better performance in both CO₂ absorption capacity and heat of reaction than MEA's results and a-MDEA's results.

Index Terms — Acetic acid, Gas purification, CO₂ control, amine absorbent.

I. INTRODUCTION

Acetic acid is used as a raw material for fine chemical products such as vinyl acetate and acetic acid ester. It is also a chemical substance widely used in such as terephthalic acid solution and dye [1]. A projected increase in the consumption of acetic acid has been reported at 4.0–4.5 % annually in China through 2020. China is expected to consume an average of 3–4 % of worldwide production [2]. The annual production of acetic acid is about 11.8 Mt/year, of which the production of acetic acid based on the methanol carbonylation technology is equivalent to about 80% [3],[4]. Processes for production of acetic acid using methanol carbonylation technology generally use noble metal catalysts such as iridium and ruthenium. The acetic acid production process based on ruthenium was widely used after being commercialized by Monsanto in 1970 [5]. In 1996, BP Chemical developed an improved methanol carbonylation process based on promoted iridium-iodide catalyst [6]. However, Bu₄NI catalyst has the disadvantage that the iodide poisons the catalyzed reaction and reduces the reaction rate to 67% or less [7]. Therefore, many researchers have tried to improve the performance of catalyst using the iridium-complex [8],[9]. The annual production of acetic acid using iridium-complex catalyst was very high, but the problem of catalyst poisoning by CO₂ occurred. Therefore, the use of CO₂ capture technology was required to separate CO₂ from the syngas.

A primary syngas manufactured through partial oxidation is commonly used to produce acetic acid [10]. The primary syngas is composed of CO (60–70 %), H₂ (30–40 %), CO₂

(1–5 %), along with CH₄ and other impurities. The H₂S present in the syngas was removed via desulfurizer, and the CO/H₂ was separated by the pressure swing adsorption process (PSA). The CO₂ in the syngas was removed by CO₂ capture technology, and the remaining CO₂ should be limited to less than 20 ppm to prevent poisoning of the catalyst. Thus, high-level purification of CO₂ is very important for increasing efficiency in the acetic acid production process. The CO₂ capture technology used in the petrochemical industry was developed for gas purification purposes. In particular, the gas purification method using amines has been widely used commercially since its development by R. Richards in 1930 [11]. The typical amine absorbents are monoethanolamine (MEA), diethanolamine (DEA), and N-methyldiethanolamine (MDEA) [12]. Amines are classified as primary, secondary, or tertiary amines depending on their structural characteristics. MEA is a primary amine, which has the advantages of low cost and high CO₂ absorption rate, but the disadvantages of low CO₂ capacity, thermal degradation, oxidative degradation, corrosion, etc [13]-[16]. DEA has a relatively lower CO₂ absorption rate than MEA does. MDEA is an absorbent used in early 1950, and has the advantage of treating H₂S and CO₂ simultaneously [17], but it has the disadvantage of a very low absorption rate [18]. In the 2000s, gas purification technology using amines was considered for application in carbon capture and storage (CCS) technology. The core technology of CCS is absorbents, and CO₂ capacity, absorption rate and regeneration energy for CO₂ capture process using a wet absorption method have been studied to evaluate the performance of absorbents. Recently, alternative absorbents in the form of cyclic amines such as

piperazine (PZ) and 2-methylpiperazine (2MPZ) have been reported for use as commercial absorbents in power plants because of their advantages of low absorption heat, high CO₂ capacity and rapid reaction rate [19],[20]. In this study, various cyclic absorbents with potassium carbonate were evaluated to control CO₂ in an acetic acid production process, one of petrochemicals. The CO₂ absorption capacity and heat of reaction were measured and compared with MEA (30 wt%) and activated MDEA (α -MDEA; 40 wt% MDEA + 5 wt% PZ), in order to confirm the applicability of cyclic amines. When each absorbent was used, the concentration of emitted CO₂ was kept below 20 ppm.

II. EXPERIMENT

The CO₂ absorption capacity and heat of reaction were measured using a continuously stirred-tank reactor (CSTR) and differential reaction calorimeter (DRC), respectively. The mixed gases (3 vol% CO₂ / balanced N₂) used in the DRC experiment were purchased from Special Gas Co. in Korea. The CSTR experiments were conducted by mixing N₂ (99.9999%) and CO₂ (99.9999%) gas. MEA (2-aminoethanol; $\geq 99\%$), PZ (piperazine; 99.0%), and potassium carbonate (K₂CO₃; 99.5%) were from Samchun Chemicals. MDEA (N-methyldiethanolamine; ≥ 99.0) from Sigma Aldrich and 2MPZ (2-methylpiperazine; 98%) from Acros Organics were also used. The following four different absorbents mixed with deionized water were used for the experimental comparison of performance: 1) Commercially available and widely used aqueous 30 wt% MEA solution, 2) α -MDEA for simultaneous treatment of H₂S and CO₂, 3) KIERSOL-N (a brand of the Korea Institute of Energy Research) [21], and 4) KIERSOL-P (a brand used for petrochemical applications).

III. EXPERIMENTAL SETUP AND PROCEDURE

A. Continuously stirred-tank reactor (CSTR)

The experimental apparatus used in this study is shown in Fig. 1. The pressure in the CSTR was maintained at 9.50 to 9.52 bar to simulate the absorber of the CO₂ capture process. In the CO₂ absorption capacity experiment, the measurement was made by supplying 500 mL of absorbent to a reactor with an internal volume of 750 mL. The reaction temperature during the experiment was controlled by a water bath. CO₂ was supplied using a sparger to maximize contact with the surface of the absorbent; the stirring was done at a constant rate of 500 r min⁻¹ during the reaction. CO₂ (3 vol%) was supplied at a constant concentration, in combination with nitrogen, using a mass flow controller. The gas supplied was injected into each reactor at a rate of 1,000 cm³ min⁻¹. The concentration of CO₂ was inspected at five-minute intervals using GC (gas chromatography;

Agilent Technologies, model 7890A).

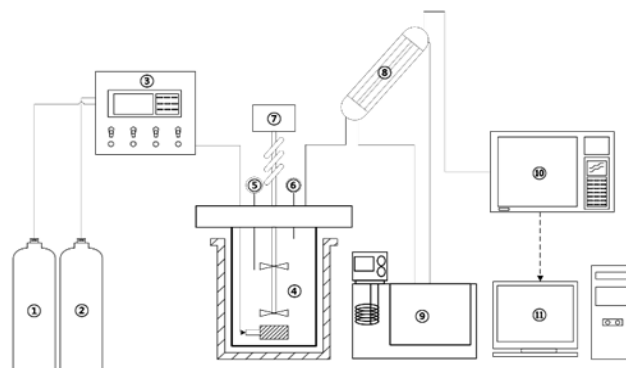

B. Differential reaction calorimeter (DRC)

Fig. 2 shows the configuration for the differential reaction calorimeter (DRC) experiment. The reactor had a double jacket structure with an inner volume of 250 mL. A total of 150 mL of the absorbent was injected into each reactor. The temperature in the reactors was kept constant during the reaction time using a thermostat. Two types of reactors were used: a reference reactor and a measurement reactor. The gas injected into the reactor was 3 vol% CO₂ mixed gas. In order to maximize the reaction area of the absorbent, a sparger was used to give the injection a constant flow rate of 150 cm³ • min⁻¹. The absorbent was stirred at a constant rate of 250 r • min⁻¹ over the entire reaction time. Gas chromatography was used to analyze the concentration of CO₂ exhausted after reaction with the absorbent inside the reactor. The absorbent underwent an exothermic reaction as it reacted with CO₂; this reaction was measured in real time by the thermocouple located inside the reactor. Differences in the measured reaction heat were stored on the computer in real time. The details of the experimental procedure are available in a previous report [22].

IV. THEORETICAL FOUNDATIONS

A. Measurement of CO₂ capacity using CSTR

The moles of CO₂ absorbed by the absorbents ($n_{\text{absorbed CO}_2}$) at each measurement point was calculated using Equation (1)-(3).

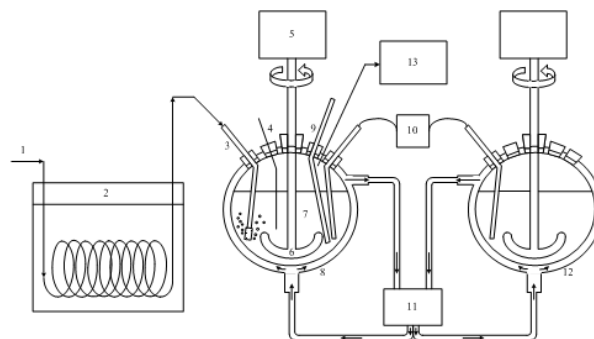

Figure 2. Schematic diagram of differential reaction calorimeter: 1) CO₂ gas (3 vol% CO₂ / balanced N₂), 2) Water bath, 3) Inlet gas port, 4) Optional probe, 5) Motor, 6) impeller, 7) Absorbent, 8) Double jacketed reactor, 9) Calibration probe, 10) Temperatures and ΔT measurements, 11) Thermostat, 12) Reference reactor, 13) Gas chromatography.

$$n_{CO_2,out} = \frac{P_{CO_2,in} \times V_{CO_2,in}}{R \times T_{CO_2,in}} \quad (1)$$

$$n_{CO_2,out} = \frac{P_{CO_2,out} \times V_{CO_2,out}}{R \times T_{CO_2,out}} \quad (2)$$

$$n_{absorbed\ CO_2} = n_{CO_2,in} - n_{CO_2,out} \quad (3)$$

$$n_{absorbed\ CO_2} = \int_0^t n_{absorbed\ CO_2} dt \quad (4)$$

where PCO₂ (atm), VCO₂ (mol/min), and TCO₂ (K) are the partial pressure, volume, and temperature of CO₂, respectively. The subscripts, 'in' and 'out' indicate inlet and outlet. CO₂ absorption capacity at saturated point was calculated using equation (4).

B. Measurement of the heat of reaction using DRC

The measurement of the heat of reaction between the absorbent and CO₂ was conducted three times: (1) calibration time before the CO₂ reaction, (2) for the CO₂ reaction, and (3) calibration time after the CO₂ reaction. The heat of reaction is indicated by temperature changes per unit time in the reference reactor and the measurement reactor. As can be seen in equation (5), the heat of reaction calibration factor Q (kJ) can be calculated using the reaction-heat-transfer coefficient (UA; W• K⁻¹) and the cumulative time changes (ΔT; K).

$$Q_{cal(1)} = UA_1 \times \int_{t_o}^{t_{end}} \Delta T dt \quad (5)$$

The UA was calculated by injecting constant energy via the calibration probe; in this study, the measurement was made three times. The heat of reaction calibration after the reaction was calculated in the same way as the heat of reaction calibration before reaction. As shown in equation (6), the total heat of reaction calibration within the reactor was calculated as the arithmetic mean of the heat of reaction calibration before the reaction and the heat of reaction calibration after the reaction.

$$UA_{average} = \frac{UV_1 + UV_2}{2} \quad (6)$$

In order to measure the heat of reaction between CO₂ and absorbent, the enthalpy of the standard state was measured based on the heat of reaction per mole of CO₂, and was found to be 40 °C.

V. RESULTS AND DISCUSSION

A. CO₂ absorption capacity

The CO₂ absorption capacity was expressed in mol of CO₂ dissolved in the absorbent per mol of absorbent (mol CO₂ •

mol absorbents⁻¹). Absorbents with high absorption capacity can dissolve large amounts of CO₂ in the CO₂ capture process and can thereby reduce operating cost. The CO₂ absorption capacity was measured to evaluate the absorption performance of each absorbent. The breakthrough curve of CO₂ is shown in Fig. 3–5 at the reaction temperature of 40–80 °C. In this figure, the y-axis is the ratio of the concentration of injected CO₂ (C_i) to the concentration of

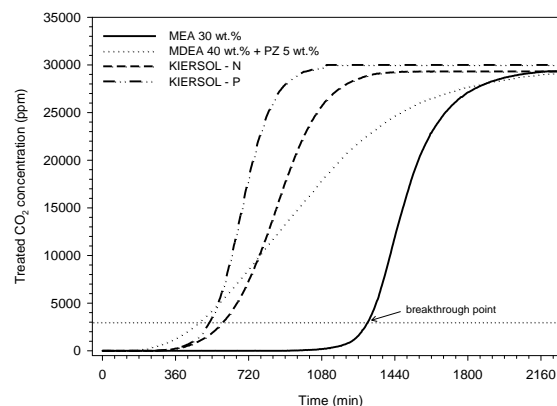

Figure 3. CO₂ absorption curve of absorbents at 40 °C.

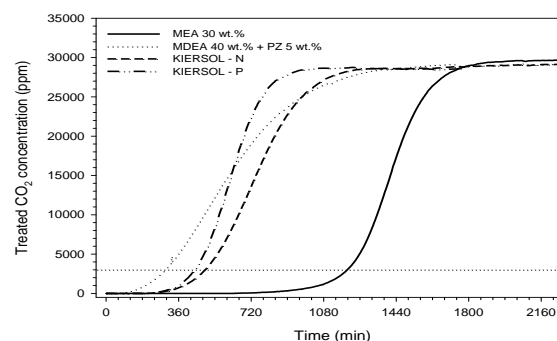

Figure 4. CO₂ absorption curve of absorbents at 60 °C.

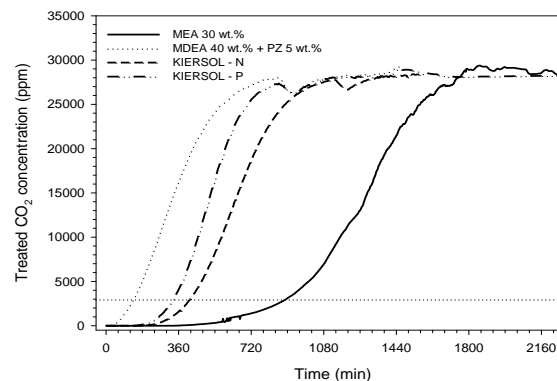

Figure 5. CO₂ absorption curve of absorbents at 80 °C

emitted CO₂ (C_o), and the x-axis is the reaction time of the CO₂ and absorbent. In general, the point at which the outlet concentration is 10% of the inlet concentration is called the breakthrough point. As shown in Fig. 3–5, the breakthrough point is reached in a short time as the temperature increases. From these results, it can be shown that the amount of absorption of CO₂ depends on the reaction temperature. Table 1 shows the amount of absorbed CO₂ in each absorbent at different temperatures. The maximum CO₂ capacity of a primary amine such as MEA is generally limited to 0.5 mol CO₂ · mol amine⁻¹ due to formation of MEA carbamate (MEACOO⁻) and protonated MEA (MEA⁺H). However, the absorption capacity of the MEA in this experiment was 0.74 mol CO₂ · mol amine⁻¹, which is higher than the theoretical value.

Table 1. CO₂ absorption capacity of each absorbent at temperatures from 40 to 80 °C

Absorbents	CO ₂ absorption capacity (mol CO ₂ · mol absorbent ⁻¹)		
	40 °C	60 °C	80 °C
MEA	0.74	0.70	0.64
α-MDEA	0.63	0.38	0.23
KIERSOL-P	1.14	0.98	0.81
KIERSOL-N	1.17	1.00	0.84

These results were affected by the simulated pressure of the absorber (9.50–9.52 bar). The results for KIERSOL-P and KIERSOL-N at 40 °C were 1.14 and 1.17 mol CO₂ · mol absorbent⁻¹, respectively. KIERSOL-P showed 1.54 times greater CO₂ absorption than MEA and 1.81 times greater CO₂ absorption than α-MDEA. The difference in CO₂ absorption capacity at 60 °C was greater than at 40 °C. And, the difference in CO₂ absorption capacity at 60 °C was higher than at 40 °C. KIERSOL-P showed 1.40 times greater CO₂ absorption capacity than MEA, and 2.58 times greater CO₂ absorption capacity than α-MDEA. The CO₂ concentration remains low (< 20 ppm) after the absorbent. The curve of CO₂ in a low range of concentration is shown in Fig. 6-8, and the time is shown in Table 2 until the concentration of CO₂ reaches 20 ppm.

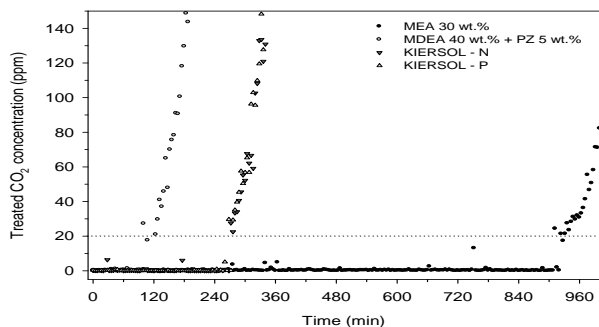

Figure 6. Initial CO₂ concentration for CO₂ absorption curve at 40 °C.

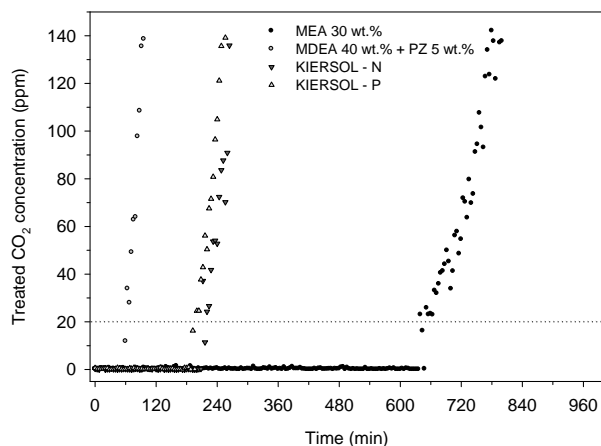

Figure 7. Initial CO₂ concentration for CO₂ absorption curve at 60 °C.

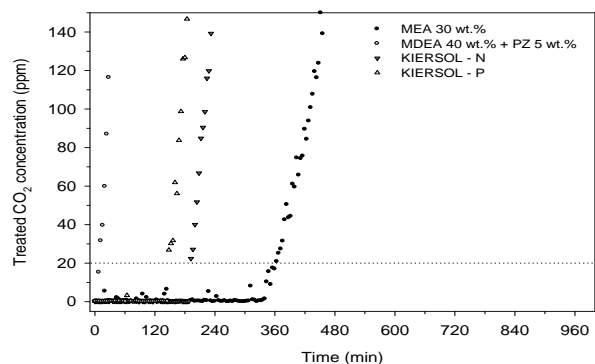

Figure 8. Initial CO₂ concentration for CO₂ absorption curve at 80 °C.

Table 2. Interval for absorbent to reach CO₂ concentration of 20 ppm.

Temperatur e (°C)	Interval (min)			
	MEA	MDEA+PZ	KIERSOL-N	KIERSOL-P
40	912	100	272	268
60	640	64	212	200
80	364	12	192	148

MEA provided the highest absorbent concentration at which the concentration of CO₂ was kept below 20 ppm.

Interval of absorbents with a CO₂ concentration of less than 20 ppm increased following the order MEA > MDEA > KIERSOL-N > KIERSOL-P.

B. Heat of reaction

High CO₂ absorption rate, high cyclic capacity and low reaction heat are required to reduce the energy requirement in the CO₂ capture process [23]. In general, the heat of reaction accounts for more than 50% of the total energy requirement and is an important indicator for evaluating the performance of the absorbent. As the reaction between CO₂ and absorbents is reversible reaction, it is possible to anticipate the heat of adsorption by measuring the heat of

endothermic reaction produced during the reaction between CO₂ and absorbents. The heat of reaction is the energy (kJ • mol⁻¹) that has increased through exothermic reaction per mol of CO₂ of each absorbent. Kim et al. found that when 30wt% MEA and CO₂ were made to react with each other at 40°C, the heat of reaction was 87.098 kJ • mol⁻¹ [24], and Carson et al. reported that the reaction between 30 wt% MEA and CO₂ at 25 °C resulted in the heat of reaction 83.15kJ • mol⁻¹ [24]. The results of this study showed that the heat of reaction of MEA was 96.00 kJ • mol⁻¹, which was higher than previous report. Although preceding research was conducted using 10-30 vol% CO₂ based on flue gases of the power plant, this study used low concentration CO₂ (3 vol%) of petrochemical process. The heat of reaction of MEA was 96.00 kJ • mol⁻¹ and that of α -MDEA was 68.22 kJ • mol⁻¹. As a result of the experiment, while the heat of reaction of KIERSOL-N and P were similar to that of α -MDEA, it was 0.73-0.65 times lower than that of MEA. As a result of measuring the heat of reaction, it could be found that KIERSOL-N and P were better than MEA in the aspects of absorption capacity and heat of reaction.

Table 3. Heat of absorption of saturated CO₂ at 40 °C

Absorbent	Absorbed CO ₂ (mol)	CO ₂ loading (CO ₂ mol • absorbent mol ⁻¹)	Enthalpy (ΔH : kJ • mol ⁻¹)
MEA	0.356	0.48	96.00
α -MDEA	0.145	0.25	68.22
KIERSOL-P	0.137	0.65	69.76
KIERSOL-N	0.160	0.59	62.83

VI. CONCLUSIONS

We assessed CO₂ absorption capacity, low concentration duration of CO₂, and the heat of reaction between absorbents and CO₂ in order to control 3vol.% CO₂ emitted during the acetic acid production process under ultra-low concentration 20ppm. As a result of the experiment, the absorption capacity of KIERSOL-N and KIERSOL-P at 40°C was 1.14-1.17 mol CO₂ • mol absorbent⁻¹, which was rather higher than that of MEA (0.74 mol CO₂ • mol absorbent⁻¹) or MDEA (0.63 mol CO₂ • mol absorbent⁻¹). Although MEA kept the concentration of CO₂ under 20ppm longer than the others, KIERSOL-N and KIERSOL-P emitted low concentration CO₂ longer than MDEA. As for the heat of reaction, α -MDEA, KIERSOL-N and KIERSOL-P showed similar results, and MEA was found to have very high heat of reaction. The study results indicate that KIERSOL-N and KIERSOL-P have high absorption capacity, low heat of reaction, and long low concentration carbon dioxide duration. Thus, KIERSOL-N and KIERSOL-P are expected to improve the efficiency of the acetic acid production process.

V. ACKNOWLEDGEMENTS

This work was supported by the Energy Demand Management Technology Program of the Korea Institute of Energy Technology Evaluation and Planning (KETEP), granted financial resource from the Ministry of Trade, Industry and Energy, Republic of Korea. (No. 20172010202060)

REFERENCES

- [1] M. T. Ashtiany, A. M. Rezaee, and M. R. Jafari Nasr, "An investigation on the effects of iodide salts in iridium catalyst in methanol carbonylation process" *Journal of Applied Chemical Researches*, vol. 4, pp. 11-18, August 2010.
- [2] HIS Market "Monochloroacetic acid" *Chemical economics handbook*, November 2016.
- [3] Grand view research, "Acetic Acid Market Analysis By Application (VAM, Acetic Anhydride, Acetate Esters, PTA) And Segment Forecasts To 2022", ISBN: 978-1-68038-0774-4, July 2015.
- [4] S. Bhaduri, and D. Mukesh "Homogeneous Catalysis: Mechanisms and Industrial Applications" *John Wiley & Sons*, 2014.
- [5] A. Haynes, P. M. Maitlis, G. E. Morris, G. J. Sunley, H. Adams, P. W. Badger, C. M. Bowers, D. B. Cook, P. I. P. Elliott, T. Ghaffar, H. Green, T. R. Griffin, M. Payne, J. M. Pearson, M. J. Taylor, P. V. Vickers, and R. J. Watt, "Promotion of Iridium-Catalyzed Methanol Carbonylation: Mechanistic Studies of the Cativa Process" *Journal of the American Chemical Society*, vol. 126, pp. 2847-2861, February 2004.
- [6] J. H. Jones "The Cativa™ Process for the Manufacture of Acetic Acid" *Platinum Metals Rev*, vol. 44, pp. 94-105, 2000.
- [7] G. J. Sunley, and D. J. Watson, "High productivity methanol carbonylation catalysis using iridium The Cativa™ process for the manufacture of acetic acid" *Catalysis Today*, vol. 58, pp. 293-307, 2000.
- [8] P. I. P. Elliott, S. Haak, A. J. H. M. Meijer, G. J. Sunley, and A. Haynes, "Reactivity of Ir(III) carbonyl complexes with water: alternative by-product formation pathways in catalytic methanol carbonylation" *Dalton Transactions*, vol. 42, pp. 16538-16546, September 2013.

- [9] G. Borah, and D. Boruah, "Ruthenium(II), rhodium(I) and iridium(I) complexes with [p-(N,N-dimethylamino)phenyl]diphenylphosphine ligand: Synthesis, characterization and rhodium-catalysed carbonylation of methanol" *Indian Journal of Chemistry*, vol. 52A, pp. 334-341, March 2013.
- [10] S. A. Al-Sayari, "Recent Developments in the Partial Oxidation of Methane to Syngas" *The Open Catalysis Journal*, vol. 6, pp. 17-28, June 2013.
- [11] A. L. Kohl, and R. B. Nielsen, "Gas Purification" Gulf Publishing Company, ISBN: 978-0-88415-220-0, 1997.
- [12] J. H. Choi, Y. E. Kim, S. C. Nam, S. H. Yun, Y. I. Yoon, and J-H Lee, "CO₂ absorption characteristics of a piperazine derivative with primary, secondary, and tertiary amino groups" *Korean J. Chem. Eng. Vol. 33*, pp. 3222-3230, June 2016.
- [13] C. Han, K. Graves, J. Neathery, and K. Liu, "Simulation of the Energy Consumption of CO₂ Capture by Aqueous Monoethanolamine in Pilot Plant" *Energy Environment Research*, vol. 1, pp. 67-80, December 2011.
- [14] Y. E. Kim, J. H. Choi, S. C. Nam, and Y. I. Yoon, "CO₂ Absorption Characteristics in Aqueous K₂CO₃ / Piperazine Solution by NMR Spectroscopy" *Industrial & Engineering Chemistry Research*, vol. 50, pp. 9306-3913, June 2011.
- [15] J. Davison, "Performance and costs of power plants with capture and storage of CO₂" *Energy*, vol. 32, pp. 1163-1176, July 2007.
- [16] S. H. Yun, Y. E. Kim, J. H. Choi, S. C. Nam, J. Chang, and Y. I. Yoon, "CO₂ absorption, density, viscosity and vapor pressure of aqueous potassium carbonate + 2-methylpiperazine" *Korean Journal of Chemical Engineering*, vol. 33, pp. 3473-3486, December 2016.
- [17] S. Y. Khan, M. Yusuf, and A. Malani, "Selection of Amine in Natural Gas Sweetening Process for Acid Gases Removal: A Review of Recent Studies" *Petroleum & Petrochemical Engineering Journal*, vol. 1, pp. 1-7, June 2017.
- [18] H. Kierzkowska-pawlak, and A. Chacuk, "Kinetics of Carbon Dioxide Absorption into Aqueous MDEA Solutions" *Ecological Chemistry and Engineering S*, vol. 17, pp. 463-475, 2010.
- [19] B. Sherman, X. Chen, T. Nguyen, Q. Xu, H. Rafique, S. A. Freeman, A. K. Voice, and G. T. Rochelle, "Carbon Capture with 4 m Piperazine / 4 m 2-methylpiperazine" *Energy Procedia*, vol. 37, pp. 436-447, 2013.
- [20] Y. E. Kim, J. H. Choi, S. C. Nam, and Y. I. Yoon, "CO₂ absorption capacity using aqueous potassium carbonate with 2-methylpiperazine and piperazine" *Journal of Industrial and Engineering Chemistry*, vol. 18, pp. 105-110, January 2012.
- [21] Y. I. Yoon, Y. E. Kim, S. C. Nam, S. K. Jeong, S. Y. Park, M. H. Youn, and K. T. Park. "Characteristics of CO₂ capture system using KIERSOL in the LNG flue gas" *Energy Procedia*, vol. 63, pp. 1745-1750, 2014.
- [22] J. H. Choi, S. H. Yoon, Y. E. Kim, Y. I. Yoon, and S. C. Nam, "The Effect of Functional Group Position of the Piperidine Derivatives on the CO₂ Absorption Characteristics in the (H₂O-Piperidine-CO₂) System" *Korean Chemical Engineering Research*, vol. 53, pp. 57-63, November 2014.
- [23] F. A. Chowdhury, H. Yamada, T. Higashii, K. Goto, and M. Onoda, "CO₂ Capture by Tertiary Amine Absorbents: A Performance Comparison Study", *Industrial & Engineering Chemistry Research*, vol. 52, pp. 8323-8331, 2013.
- [24] I. Kim, and H. F. Svendsen, "Heat of Absorption of Carbon Dioxide (CO₂) in Monoethanolamine (MEA) and 2-(Aminoethyl) Ethanolamine (AEEA) Solutions." *Industrial & Engineering Chemistry Research*. vol. 46, pp. 5803-5809, July 2007.
- [25] J. K. Carson, K. N. Marsh, and A. E. Mather, "Enthalpy of Solution of Carbon Dioxide in (Water + Monoethanolamine, or Diethanolamine, or N-Methyldiethanolamine) and (Water + Monoethanolamine + N-Methyldiethanolamine) at T= 298.15 K." *The Journal of Chemical Thermodynamics*, vol. 32, pp. 1285-1295, September 2000.

The Influence of Environment on the Delivery of Innovation in Construction Projects Considering the Mediation Effect of Project Managers' Competences: A Literature Review and Research Framework

Dr. Afaf Hassan

Consultant, Elite MAF Events and Exhibitions, Dubai, United Arab Emirates

Abstract— This paper discusses the relationship between construction environment and the delivery of innovation in construction projects in the United Arab Emirates, and considers the construction project managers' (CPMs') competences as a mediator of this relationship. The discussion arises mainly based on the considerable controversy regarding these relationships that appear in the literature. In order to resolve this controversy, a research framework is established preceded by a theoretical discussion of the innovation diffusion theory (IDT) and the high performance managerial competences (HPMC) theory in different organizational contexts. The primary proposition of this framework is that the construction environment will influence the delivery of innovation in construction projects, given that the construction project managers' competences can have a substantial mediation effect on this relationship. The model of this research is then reflected in terms of different outcomes related to construction environment, construction project managers' competences, and the delivery of innovation in construction projects.

Index Terms—construction environment, delivery of innovation, project manager competences, construction projects

I. INTRODUCTION

Construction industry has numerous barriers and resistance to innovation [1]. Unfortunately, innovation has many challenges in this industry such as pressure from clients to meet targets [2], dealing with culture diversity [3], getting adapted to the existing market orientation [4], employees' resistance [5], uncertainty [6], lack of required mechanisms [7], characteristics and structure of construction projects [8], understanding and delivering the common goals between construction and innovation [3], [6], [9], and having appropriate management support for innovation [10]. Among the management, this paper focuses of construction project managers, as they are considered to be the backbone for implementing construction projects and delivering innovation in construction projects [11]. In particular, CPMs are responsible for meeting project targets (i.e. schedule, cost, safety, and quality) [12], enhancing productivity [11], controlling resource [13], leading project team members [14]. Project managers also work hard on improving the outcome of their project teams, addressing the needs of

construction project team members [15], recognize the potential sources of conflict and when they may occur [16], and providing a better project culture [15]. Accordingly, this paper studies the role of construction environment and the delivery innovation in construction projects. It also emphasizes the construction project managers' competences as a mediator for this relationship. This discussion is important because it clarifies the most influencing environmental factors on the delivery of innovation in construction projects. It also highlights the most important CPMs' competences that have considerable effect on the relationship between the construction environment and the delivery of innovation in construction projects.

II. LITERATURE REVIEW

Before discussing the literature review, it is necessary to clarify what is meant by construction environment, the delivery of innovation in construction projects, and construction project manager competences. The construction environment is defined as the construction project environment that can be a poor or supporting environment for innovation considering the influences of

the stakeholders, resources, culture, and the market [1], [8], [13], [17]-[24]. The delivery of innovation in construction projects is described as a positive implementation of innovation that meets the initial requirements, which are associated with the time, cost, and quality of a particular construction project [3], [5], [8], [9], [11] [25]-[27]. Whereas, the CPM competences are recognized as personal characteristics that allow a construction project managers to successfully complete the tasks they are assigned for, where each competency is a unique combination of behaviors, abilities, skills, and knowledge [18], [28], [29]-[32].

Discussions on the relationship between construction environment and the delivery of innovation in construction projects do not appear frequently in the literature. Also, there is a lack of literature about the mediation effect of the CPMs' competences on such a relationship. Basically, there is a small amount of literature that is supported by theoretical conceptions or by empirical evidences. A review of these papers has led to a conclusion that numerous arguments support the positive relationship between construction environment, construction project managers' competences, and the delivery of innovation in projects, implying that the CPMs' competences can mediate the relationship between the construction environment and the delivery of innovation in construction projects. These arguments are considered in turn. These arguments are considered in turn, as presented in the next section.

A. Arguments in support of the relationship between construction environment and the delivery of innovation in construction projects

Debates that support a positive relationship between construction environment and the delivery of innovation in construction projects suggest that construction environment is usually affected by internal factors (i.e. time requirements, financial strength, cooperative conduct, service offer, and knowledge strength), or external factors (i.e. regulations degree; innovation acceptance of the client; dependency on client, location, and procurement form) [3]. Thus, a construction project environment that aims to deliver innovation involves external factors (i.e. market, partners, customers, and funds) and internal factors (i.e. culture, resources, and type of business model) [33]. Hence, construction project stakeholders are often strongly involved in innovation tasks as this in return can lead to better development of construction projects [34]. Also, CPMs are progressively concerned about creating closer interactions with customers and end users that have conventionally been weak [35]. Further, CPMs promote innovation on construction projects through creating suitable climate that inspires innovation and facilitates resource supply [1]. A positive construction climate is effective, as it motivates the creation of novel ideas,

supports efforts to achieve new ideas, and assist in overcoming innovation challenges through emphasizing core values and strategies [8]. This explains the significance of such a climate for the delivery of innovation in construction projects. More specifically, a supportive construction climate can entail generating of an innovative culture that values change, innovation, and strategic vision, among others; revealing commitment of essential resources such as money, time, manpower, and information; showing tolerance of risk, failure, and mistakes; and recognizing and rewarding creativeness [1]. Such acts indicate the existence of a supportive and positive construction environment that can successfully deliver innovation in construction projects. Nevertheless, implementing innovation in construction projects requires great commitment of time, cost, resources, and energy, and thereafter a simple introduction about how innovation can be delivered [36]. Ultimately, the environment of construction projects positively affects the delivery of innovation, as it brings a favorable organizational image, partnerships, national and regional recognition, knowledge transfer, satisfaction of end users, and quality improvement [9].

B. Arguments in support of the relationship between construction environment and CPMs' competences

Viewpoints that support a positive relationship between construction environment and CPMs' competences indicate that it is essential for construction project managers to use their competences effectively in their surrounding environment, that is progressively complicated in nature, in order to meet the required innovation targets of recent construction projects [37]. In addition, scholars have provided different arguments about the typical competences of CPMs working in a construction environment. For instance, some researchers have presented nine CPMs competences that are decision-making, leadership, communication, team building, honesty and integrity, mutuality and approachability, learning, external relations and self-efficacy [26]. A different scholar has clustered the CPMs' competences into four categories that are business, technical, management, and human knowledge and skills [38]. Later, management knowledge and skills; technical knowledge and skills; business knowledge; and skills management knowledge and skills have been considered as imperative CPMs' competences that can influence the construction project environment [38]. Yet, it has been argued that the construction environment is influenced by twelve CPM competences that are humility, character, leadership, consistency, commitment, curiosity, communication Skills, people Skills, effectiveness, knowledge, experience, and willingness to achieve [11]. Recently, it has been found that the influence of CPM competences on the construction environment can be assessed using three critical measures,

which are (1) attitude (i.e. assertiveness, self-confidence, and aspiration), (2) management skills (i.e. decision making, problem solving, and negotiation), (3) knowledge (i.e. using project management software, selecting appropriate methodologies, and managing projects with experience) [39].

C. Arguments in support of the relationship between CPMs' competences and the delivery of innovation in construction projects

Arguments that support a positive relationship between CPMs' competences and the delivery of innovation in construction projects point out that CPMs can offer enough resources and a nonstop support to innovation, and hence create a favorable construction environment or organizational culture that encourages and eases project manager's role in delivering innovation in a particular construction project [1]. Hence, it is necessary to acknowledge that CPMs' competences allow them to inspire others through following high ethical standards of behaviors, and avoiding dishonest practices that decrease trust and confidence of all involved members [13]. They also enable innovation on site and improve the overall project outcome [1]. This highlights the key responsibility of CPMs towards innovation, which is applying their competences that allow them to work as facilitators for the delivery of innovation. At the same time, it is important to point out that once CPMs are fully persuaded about the advantages of delivering innovation effectively, they adopt and carry it in a unique manner [1]. This indicates that CPMs can act better towards innovation, in spite of their traditional role of controlling cost, time, quality, safety and environmental matters [13]. In return, CPMs can deliver innovation successfully in longer term [34]. In justification, meeting the target schedule, cost, and quality is essential for construction project managers, but presently delivering innovation is becoming a basic necessity as well [3]. Hence, in order to deliver innovation, CPMs have many responsibilities [3]. For example, they can endorse creative and innovative ideas openly, make attentive strategic decisions about the direction of innovation activities and provide hierarchical and systematic support throughout innovation implementation processes [3]. Also, CPMs can communicate the importance of innovative solutions thoroughly, encourage individuals' freedom to become innovative, and motivate innovative employees with their hierarchal potential [3].

In construction industry, construction project managers, who acquire the proper competences, encourage the successful implementation and delivery of innovative [23]. This implies that CPMs who have the needed competences can lead to an effective delivery of innovation in construction projects. In other words, CPM's complicated role in construction innovation has a considerable influence in realizing project aims and objectives in order

to improve innovative practices on site [1]. Such a major role is often accompanied by CPMs' competence and skills [1]. On the other side, CPMs might not have the required competences to satisfy their roles; in return, this might result in failure to deliver innovation in a successful manner. Lately, CPMs are gradually expected to fulfill their potential to deliver innovation in projects, and to confront and advance their competences [23]. Their involvement in innovative tasks has become a fundamental element to inspire project team members to delivery of innovation successfully in construction projects [23]. This signifies that developing the right CPMs' competences can allow them deliver to innovation and cope up with various challenges that might occur during construction projects. Eventually, the main roles of CPMs are to improve their professional competences, and to be accountable for delivering innovation targets within the initial constraints of cost, schedule, quality, and safety requirements [12]. This means that competences can be treated as a mediator that acts between job's requirements and individuals' capacity [40].

D. Discussion

When discussing the relationships presented above, a greater focus is placed on the direct influence of the construction environment on the delivery of innovation [1], [3], [8], [9], [33], [34], [35], [36]. At the same time, the previous debates indicate that the construction project manager competences can indirectly influence this relationship. In other words, the CPM competences can mediate the relationship between construction environment and the delivery of innovation in construction projects [1], [3], [11], [12], [13], [23], [26], [34], [37], [38], [39].

III. THE MULTIDIMENSIONALITY OF CONSTRUCTION ENVIRONMENT, CPM COMPETENCES, AND THE DELIVERY OF INNOVATION IN CONSTRUCTION PROJECTS

In this research, the dimensions of the construction environment, construction project managers' competences, and the delivery of innovation in construction projects are briefly detailed as follows:

A. Dimensions of the construction environment

The construction environment criteria that are most frequently revealed in literature, to have an influence on the delivery of innovation in construction projects are:

- Stakeholders: this involves stakeholders' decision-making abilities, collaboration, and satisfaction [9], [13], [21].
- Resources: this covers resources' selection, and appropriate allocation of resources [17], [18], [23].

- Culture: this comprises cultures' diversity overcome, and innovative culture encouragement [1], [24].
- Market: this entails market competitive advantage, market orientation, and the existence of new markets [19], [20], [22].

B. Dimensions of CPMs' competences

The CPM competencies that are most frequently mentioned in literature, to have an influence on the delivery of innovation in construction projects are:

- Leadership competences are important for CPMs, as they allow them to be effective and delegate the different missions appropriately [11]. Being initiative, influencing others, making successful decisions, being flexible, and building teams are good examples of these competences [14], [41], [42].
- Communication competences complement the tasks of a CPM, as they can articulate ideas in a clear, simple, and logical way to improve individuals' effectiveness [11]. Some of these competences are Listening, speaking and presenting ideas, writing, computer skills, and Communication tone [11], [23], [38].
- Teamwork competences are seen as a combined action of a group of individuals, specifically when these actions are effective and well organized [44]. For instance, sharing knowledge; supporting and collaborating, Conflict resolution; Building, developing, and motivating; and Recognition and reward are common examples for these competences [26], [38], [39], [42], [43].

C. Dimensions of the delivery of innovation in construction projects

The criteria for measuring the delivery of innovation in construction projects that are most frequently mentioned in literature are:

- Time required to deliver innovation: this includes speed of time from ideas creation to scope change, responses to the scope change in a timely manner, and the innovative ideas resulting in better control over the schedule of a construction project [3], [5], [9], [11], [26].
- Cost required to deliver innovation: this covers shareholder expenditures for applying new ideas; workplace expenses for employee attraction, motivation, and retention; Customer and market payments to improve market share and customers' loyalty; and innovating ideas resulting in better control over the cost of a construction project [3], [8], [26].
- Quality required to deliver innovation: this involves enhanced quality of communication between the project team members and end users; innovative ideas improving users' feelings about innovation; richness and robustness of innovation platforms; and innovative ideas resulting in better control over the quality of a construction project [25]-[27].

IV. SUMMARY AND RESEARCH FRAMEWORK

This paper has demonstrated the arguments existing in the literature concerning the relationship between the construction environment and the delivery of innovation in construction projects. It also highlights the mediation effect of construction project managers' competences on this relationship. Following these associations is a theoretical discussion focusing the direct relationship between the construction environment and the delivery of innovation in construction projects, and the indirect (mediation) effect of the CPM competences on such a relationship.

This leads to specific questions that are worthy of investigation. Accordingly, the areas of research interest are:

- What is the relationship between the construction environment and the delivery of innovation in construction projects?
- What is the impact of the construction project manager competences on the relationship between construction environment and the delivery of innovation in construction projects?

Given the literature review conducted thus far, these questions have not been addressed thoroughly in the past studies concerning the construction environment, competences, and innovation fields. These questions mentioned above, hence, present the gap in the literature on construction environment, CPMs' competences, and the delivery of innovation in construction projects. In the interest of filling this gap, a research framework is developed, as shown in Fig. 1. The right-hand side presents the adopted measurements in this study for the construction environment that are culture, market, resources, and stakeholders in order to examine their influence on the delivery of innovation in construction projects. The left-hand side illustrates the embraced measurements in the current research for the delivery of innovation in construction projects that are cost, time, and quality required to deliver innovation. The bottom side demonstrates the selected measurements in this paper for the CPMs' competences that are leadership, communication, and teamwork competences in order to investigate their mediation effect on the relationship between construction environment and the delivery of innovation in construction projects.

The Influence of Environment on the Delivery of Innovation in Construction Projects Considering the Mediation Effect of Project Managers' Competences: A Literature Review and Research Framework

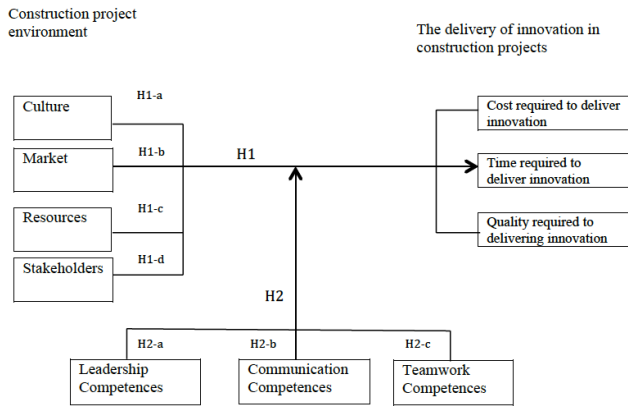

Fig. 1. Research framework

Furthermore, this research adopts the innovation diffusion theory and high performance managerial competences theory to develop the conceptual model shown in Figure 1. In brief explanation, the IDT states that the potential end users decide to adopt or reject an innovation according to beliefs and viewpoints that they form about the innovation [45]. This theory highlights the importance of construction environment for the delivery of innovation in construction projects. It also indicates that a construction environment can influence construction project manager, and this in return, may affect his abilities to deliver innovation in construction projects. Whereas, the HPMC theory is defined as a group of related behaviors that has been originated empirically to differentiate high performing from average performing individuals in terms of related work output measures [46]. This theory suggests that the competences of a construction project manager (high-performance competences or average performance competences) can be considered as a mediator for the relationship between construction environment and the delivery of innovation in construction projects [46]. Consequently, Several scholars argue that innovation needs to be implemented in a supportive construction environment in order for it to be delivered successfully. This means that it is the construction environment that can determine the direct results of the delivery of innovation in construction projects [1], [3], [8], [9], [33]-[36]. Whereas, the construction project manager competences can have an indirect affect on this relationship [1], [3], [11], [13], [12], [23], [26], [34], [37], [38], [39]. As such, the main hypothesis and sub-hypotheses concerning the direct relationship between the construction environment and the delivery of innovation in construction projects (illustrated in Fig. 1) are as follows:

H1: There is a positive relationship between construction environment and the delivery of innovation in construction projects.

H1-a There is a positive relationship between construction culture and the delivery of innovation in construction projects.

H1-b There is a positive relationship between construction Market and the delivery of innovation in construction projects.

H1-c There is a positive relationship between construction Resources and the delivery of innovation in construction projects.

H1-d There is a positive relationship between construction Stakeholders and the delivery of innovation in construction projects.

In addition, the main hypothesis and sub-hypotheses concerning the mediation effect of the construction project managers' competences on the relationship between the construction environment and the delivery of innovation in projects (shown in Fig.1) are as follows:

H2: CPM competences mediate the relationship between construction environment and the delivery of innovation in construction projects.

H2-a: CPM leadership competences mediate the relationship between construction environment and the delivery of innovation in construction projects.

H2-b: CPM communication competences mediate the relationship between construction environment and the delivery of innovation in construction projects.

H2-c: CPM teamwork competences mediate the relationship between construction environment and the delivery of innovation in construction projects.

In summary, the objective of the research is to examine the appropriateness of the model, shown in Fig. 1, by linking the left-end and the right-end relationships to study the relationship between the construction environments and the delivery of innovation in construction projects. Also, through assessing the mediation effect of the construction project managers' competences on this relationship. Currently, the author is designing a questionnaire that will be used to collect data from a large sample of United Arab Emirates construction organizations. These data will be used to test the direct and indirect (mediation) relationships shown in Fig. 1 subsequently and as hypothesized. The results will be reported in future articles.

REFERENCES

The Influence of Environment on the Delivery of Innovation in Construction Projects Considering the Mediation Effect of Project Managers' Competences: A Literature Review and Research Framework

- [1] Dulaimi, M., Nepal, M. & Park, M. (2005). A hierarchical structural model of assessing innovation and project performance. *Construction Management and Economics*, 23 (6), pp. 565-577.
- [2] Gann, D. (2000). *Building Innovation: Complex Constructs in a Changing World*. London: T. Telford.
- [3] Hartmann, A. (2006). The context of innovation management in construction firms. *Construction Management and Economics*, 24 (6), pp. 567-578.
- [4] Reichstein, T., Salter, A. & Gann, D. (2005). Last among equals: a comparison of innovation in construction, services and manufacturing in the UK. *Construction Management and Economics*, 23 (6), pp. 631-644.
- [5] Chuang, E., Jason, K. & Morgan, J. (2011). Implementing complex innovations. *Health Care Management Review*, 36 (4), pp. 369-379.
- [6] O'Connor, G. & Rice, M. (2013). A Comprehensive Model of Uncertainty Associated with Radical Innovation. *Journal of Product Innovation Management*, 30, pp. 2-18.
- [7] Murphy, M., Perera, S. & Heaney, G. (2015). Innovation management model: a tool for sustained implementation of product innovation into construction projects. *Construction Management and Economics*, 33 (3), pp. 209-232.
- [8] Gambatese, J. & Hallowell, M. (2011). Enabling and measuring innovation in the construction industry. *Construction Management and Economics*, 29 (6), pp. 553-567.
- [9] Ozorhon, B. (2013). Analysis of Construction Innovation Process at Project Level. *Journal of Management in Engineering*, 29 (4), pp. 455-463.
- [10] Kelley, D. & Lee, H. (2010). Managing Innovation Champions: The Impact of Project Characteristics on the Direct Manager Role. *Journal of Product Innovation Management*, 27 (7), pp. 1007-1019.
- [11] Rojas, E. (2013). Identifying, Recruiting, and Retaining Quality Field Supervisors and Project Managers in the Electrical Construction Industry. *Journal of Management in Engineering*, 29 (4), pp. 424-434.
- [12] Edum-Fotwe, F. & McCaffer, R. (2000). Developing project management competency: perspectives from the construction industry. *International Journal of Project Management*, 18 (2), pp. 111-124.
- [13] Hills, M., Fox, P., Skitmore, M., Hon, C. & Fong, P. (2008). The role of project managers in construction industry development. *AACE International Transactions*, p. DE141.
- [14] Boss, R. (2000). Is the leader really necessary? The longitudinal results of leader absence in team building. *Public Administration Quarterly*, 23 (4), pp. 471-486.
- [15] Tanner, K. (2008). *The entrepreneur's guide to hiring and building the team*. Westport, Conn.: Praeger.
- [16] Jiang, B. & Heiser, D. (2004). The eye diagram: A new perspective on the project life cycle. *Journal of Education for Business*, 80 (1), pp. 10-16.
- [17] Bohlmann, J., Spanjol, J., Qualls, W. & Rosa, J. (2013). The Interplay of Customer and Product Innovation Dynamics: An Exploratory Study. *Journal of Product Innovation Management*, 30 (2), pp. 228-244.
- [18] Drejer, A. (2001). How can we define and understand competencies and their development?. *Technovation*, 21 (3), pp. 135-146.
- [19] Ernst, H., Kahle, H., Dubiel, A., Prabhu, J. & Subramaniam, M. (2015). The Antecedents and Consequences of Affordable Value Innovations for Emerging Markets. *Journal of Product Innovation Management*, 32 (1), pp. 65-79.
- [20] Evanschitzky, H., Eisend, M., Calantone, R. & Jiang, Y. (2012). Success Factors of Product Innovation: An Updated Meta-Analysis. *Journal of Product Innovation Management*, 29, pp. 21-37.
- [21] Olander, S. (2007). Stakeholder impact analysis in construction project management. *Construction Management and Economics*, 25 (3), pp. 277-287.
- [22] Paladino, A. (2007). Investigating the Drivers of Innovation and New Product Success: A Comparison of Strategic Orientations. *Journal of Product Innovation Management*, 24 (6), pp. 534-553.
- [23] Vila, L., Pérez, P. & Coll-Serrano, V. (2014). Innovation at the workplace: Do professional competencies matter?. *Journal of Business Research*, 67 (5), pp. 752-757.
- [24] Wei, Y., O'Neill, H., Lee, R. & Zhou, N. (2013). The Impact of Innovative Culture on Individual Employees: The Moderating Role of Market Information Sharing. *Journal of Product Innovation Management*, 30 (5), pp. 1027-1041.
- [25] Bossink, B. (2002). The strategic function of quality in the management of innovation. *Total Quality Management*, 13 (2), pp. 195-205.
- [26] Dainty, A., Cheng, M. & Moore, D. (2003). Redefining performance measures for construction project managers: an empirical evaluation. *Construction Management and Economics*, 21 (2), pp. 209-218.
- [27] Jayaram, J., Oke, A. & Prajogo, D. (2014). The antecedents and consequences of product and process innovation strategy implementation in Australian manufacturing firms. *International Journal of Production Research*, 52 (15), pp. 4424-4439.
- [28] Boyatzis, R. (1982). *The competent manager*. 1st edn. New York: Wiley.
- [29] Liikamaa, K. (2015). Developing a Project Manager's Competencies: A Collective View of the Most Important Competencies. *Procedia Manufacturing*, 3, pp. 681-687.
- [30] Long, C. & Ismail, W. (2011). An analysis of the relationship between HR professionals' competencies and

- firms' performance in Malaysia. *The International Journal of Human Resource Management*, 22 (5), pp. 1054-1068.
- [31] Mashhoodi, M. (2010). Competency approach in human resource management. *Tadbir Journal*, Vol. 215, p.14.
- [32] Skulmoski, G. & Hartman, F. (2010). Information systems project manager soft competencies: A project-phase investigation. *Project Management Journal*, 41 (1), pp. 61-80.
- [33] Lahi, A. & Elenurm, T. (2015). SME open innovation implicating factors in different innovation phases. *International Journal of Management Science & Technology Information*, (16), pp. 29-45.
- [34] Powl, A. & Skitmore, M. (2005). Factors hindering the performance of construction project managers. *Construction Innovation*, 5 (1), pp. 41-51.
- [35] Bygballe, L. & Ingemansson, M. (2014). The logic of innovation in construction. *Industrial Marketing Management*, 43 (3), pp. 512-524.
- [36] Piening, E. & Salge, T. (2015). Understanding the Antecedents, Contingencies, and Performance Implications of Process Innovation: A Dynamic Capabilities Perspective. *Journal of Product Innovation Management*, 32 (1), pp. 80-97.
- [37] Ogunlana, S., Siddiqui, Z., Yisa, S. & Olomolaiye, P. (2002). Factors and procedures used in matching project managers to construction projects in Bangkok. *International Journal of Project Management*, 20 (5), pp.385-400.
- [38] Abu Bakar, A., Abdul Razak, A., Abd Karim, N., Yusof, M. & Modifa, I. (2011). The role of project managers in improving project performance in construction: an Indonesian experience. *International Journal of Academic Research*, 3 (6), pp. 164-169.
- [39] Dziekoński, K. (2017). Project Managers' Competencies Model for Construction Industry in Poland. *Procedia Engineering*, 182, pp. 174-181.
- [40] Shet, S., Patil, S. & Chandawarkar, M. (2017). Framework for methodical review of literature on leadership competencies. *Cogent Business & Management*, vol. 4 (1), pp. 1-12.
- [41] Howell, J., Shea, C. & Higgins, C. (2005). Champions of product innovations: defining, developing, and validating a measure of champion behavior. *Journal of Business Venturing*, 20 (5), pp. 641-661.
- [42] Takey, S. & Carvalho, M. (2015). Competency mapping in project management: An action research study in an engineering company. *International Journal of Project Management*, 33 (4), pp. 784-796.
- [43] Anderson, S. (1992). Project quality and project managers. *International Journal of Project Management*, 10 (3), pp. 138-144.
- [44] Oxford Dictionaries | English. (2018). competence - definition of competence in English | Oxford Dictionaries. [online] Available at: <https://en.oxforddictionaries.com/definition/competence> [Accessed 15 Jan. 2019].
- [45] Agarwal, R. (2000). Individual acceptance of information technologies. *Educational Technology Research and Development*, 40, pp. 90-102.
- [46] Cockerill, T., Hunt, J. & Schroder, H. (1995). Managerial Competencies: Fact or Fiction?. *Business Strategy Review*, 6 (3), pp. 1-12.

Dynamic Modeling and Analysis of a Self Voltage Regulating Three Phase Self-Excited Induction Generator

^[1] M. Rizwan Khan, ^[2] M. Faisal Khan

^[1] Department of Electrical Engineering, Aligarh Muslim University, Aligarh (U.P.)-202002 ,

^[2] Electrical Engineering Section, University Polytechnic, Aligarh Muslim University, Aligarh (U.P.)-202002

Abstract:- dynamic modeling and analysis of a selfvoltage regulating, short shunt three-phase selfexcited induction generator (SEIG) is undertaken in this paper. The derived d-q model of SEIG is implemented in terms of a simulation model to carry out its performance analysis under no-load and loading conditions. To assess the performance for a practically viable operation, the resistive-inductive (RL) load of 0.9 lagging power factor is considered for assessing SEIG performance. In order to establish the veracity of proposed analysis the simulated results are experimentally verified.

Index terms – six-phase SEIG; self excited induction generator; RL load; short shunt; SEIG test rig

I. INTRODUCTION

Due to their squirrel cage construction, the self excited induction generators (SEIGs) offer rugged and fault tolerant operation which is the prime requirement in their field of application [1,2]. Foremost operating constraint associated with SEIGs is finding a tangible mean to fulfill their reactive power requirement [3]. Most conducive strategy in this regard has been to connect capacitances across their terminals to facilitate self excitation [4,5]. Equipped with optimum excitation capacitances, SEIG generates voltage across its terminals as soon as it is supplied required kinetic energy from the rotor side [6,7]. In turn, the rotor gets mechanical energy from a suitable prime mover such as a wind or mini/micro hydro turbine. SEIGs have inherently poor voltage regulation. Thus, in order to make them practically viable, SEIGs have to be able to self regulate their terminal load voltage. While various schemes may be considered in this regard [8]-[14], the one selected for the implementation should adhere to over all spirit of the SEIG system and must not adversely affect the ruggedness of the system. In this paper detailed d-q modeling, simulink implementation and performance analysis of a short shunt SEIG [4,12,15] is presented.

Nomenclature	
Symbol	Description
R_s, R_r, R_L	stator, rotor and load resistances (Ω)
L_{s1}, L_{r1}	stator & rotor leakage inductances (H)
Ψ_{sd}, Ψ_{sq}	d and q axes stator flux(Wb)
Ψ_{rd}, Ψ_{rq}	d and q axes rotor flux(Wb)
Ψ_{rd0}, Ψ_{rq0}	d and q axes initial rotor flux(Wb)
V_{dcap}, V_{qcap}	d and q axes instantaneous voltages across excitation capacitance (V).
V_{dscs}, V_{qscs}	d and q axes instantaneous voltages across series capacitance (V).
V_{qcap}^0, V_{dcap}^0	constants representing d and q axes voltages due to initial charge on excitation capacitances(V)
v_{rq}^0, v_{rd}^0	constants representing rotor induced voltages along d and q axes due to remnant flux of rotor(V)
V_L	load voltage (V)
L_m	magnetizing inductance (H)
L_L	load inductance (H)
I_L	load Current(A)
i_{dcap}, i_{qcap}	d and q axes capacitor currents(A)
i_{sd}, i_{sq}	d and q axes stator currents(A)
i_{rd}, i_{rq}	d and q axes rotor currents(A)
i_{Ld}, i_{Lq}	d and q axes load currents(A)
I_s	stator current(A)
I_m	magnetizing current(A)
I_c	excitation capacitor current(A)
ω_r	rotor electrical speed(rads/sec)

II. MODELING OF SEIG

The d-q model of a three phase short shunt SEIG is depicted in Fig. 1[15,16]. The mathematical model of an induction machine in generation mode can be represented by (1) [15,16].

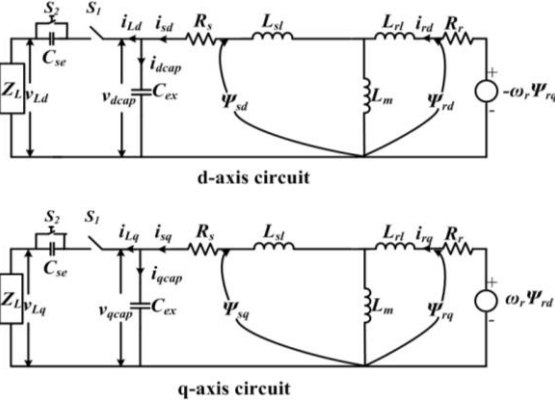

Fig. 1 d-q model of a three phase SEIG

$$p \begin{bmatrix} i_{sq} \\ i_{sd} \\ i_{rq} \\ i_{rd} \end{bmatrix} = \frac{1}{L_m^2 - L_s^2} \begin{pmatrix} -L_r R_s & -L_m^2 \omega_r & L_m R_r & -L_m \omega_r L_r \\ L_m^2 \omega_r & -L_s R_s & L_m \omega_r L_r & L_m R_r \\ L_m R_s & L_m \omega_r L_s & -L_s R_r & -L_r \omega_r L_s \\ -L_m \omega_r L_s & L_m R_s & -L_r \omega_r L_s & -L_s R_r \end{pmatrix} \begin{bmatrix} i_{sq} \\ i_{sd} \\ i_{rq} \\ i_{rd} \end{bmatrix} + \begin{bmatrix} -L_r & 0 & L_m & 0 \\ 0 & -L_r & 0 & L_m \\ L_m & 0 & -L_s & 0 \\ 0 & L_m & 0 & -L_s \end{bmatrix} \begin{bmatrix} v_{qcap} \\ v_{dcap} \\ v_{rq} \\ v_{rd} \end{bmatrix} \quad (1)$$

In (2) to (4) some of the variables represent machine parameters and may be calculated from the standard tests available for the same [17]. However, besides the standard machine parameters the magnetizing inductance L_m (which is dynamic for generator operation) and the stator and rotor induced voltages have to be found for the solution.

Modeling of Excitation Capacitance

$$v_{qcap} = \frac{1}{C_{ex}} \int i_{qcap} dt + V_{qcap}^0 \quad (2)$$

$$v_{dcap} = \frac{1}{C_{ex}} \int i_{dcap} dt + V_{dcap}^0 \quad (3)$$

Here, $i_{dcap} = i_{sd}$ and $i_{qcap} = i_{sq}$

Modeling of Series Capacitance

$$v_{dcse} = \frac{1}{C_{se}} \int i_{Ld} dt \quad (4)$$

$$v_{qcse} = \frac{1}{C_{se}} \int i_{Lq} dt \quad (5)$$

Modeling of Load

$$p i_{Lq} = \frac{v_{qcap}}{L_L} - \frac{R_L}{L_L} i_{Lq} - \frac{1}{L_L C_{se}} \int i_{Lq} dt \quad (6)$$

$$p i_{Ld} = \frac{v_{dcap}}{L_L} - \frac{R_L}{L_L} i_{Ld} - \frac{1}{L_L C_{se}} \int i_{Ld} dt \quad (7)$$

Now, $i_{dcap} = i_{sd} - i_{Ld}$ and $i_{qcap} = i_{sq} - i_{Lq}$, thus:

$$v_{qcap} = \frac{1}{C_{ex}} \int (i_{sq} - i_{Lq}) dt + V_{qcap}^0 \quad (8)$$

$$v_{dcap} = \frac{1}{C_{ex}} \int (i_{sd} - i_{Ld}) dt + V_{dcap}^0 \quad (9)$$

$$v_{Lq} = v_{qcap} - v_{qcse} \quad (10)$$

$$v_{Ld} = v_{dcap} - v_{dcse} \quad (11)$$

III. RESULTS AND DISCUSSION

The experimental set-up details and the equipment parameters are given in Appendix. In this section no-load and load performance of machine is assessed.

A. Selection of Optimum Capacitances and Extraction of Magnetizing Characteristic

The optimum excitation (shunt) and the compensation (series) capacitances have been evaluated experimentally on the studied machine as 15 μF (per phase) and 40 μF respectively as they gave best voltage regulation at full load of unity pf. The magnetizing characteristic is evaluated through synchronous speed test [15]-[18] of the studied SEIG. The extracted magnetizing characteristic is given as:

$$L_m = -5.3635e^{-009} V_{ph}^3 - 1.8533e^{-007} V_{ph}^2 + 0.0029168 + 1.11034 \quad (12)$$

B. Effect of Speed Variation on No-load Voltage

The effect of speed variation on various SEIG parameters is assessed through the simulation results depicted in Fig. 3. For a marginal decrease in speed from 1500 rpm to 1422 rpm the generated no-load voltage drops to 135 V from the rated no load value of 230 V. This implies that for a drop in speed by about 5% of the rated value the generated no-load voltage drops by more than 58%. Also, it is seen that below 1420 rpm the SEIG loses excitation completely causing the voltage collapse. Alternately, when the speed is increased by 8% the generated voltage increases by 15 % to 265 V. Therefore, the change in generated voltage is sharper when the speed is decreased as against when it is increased. The variation in SEIG stator current attains the similar dynamics as the voltage.

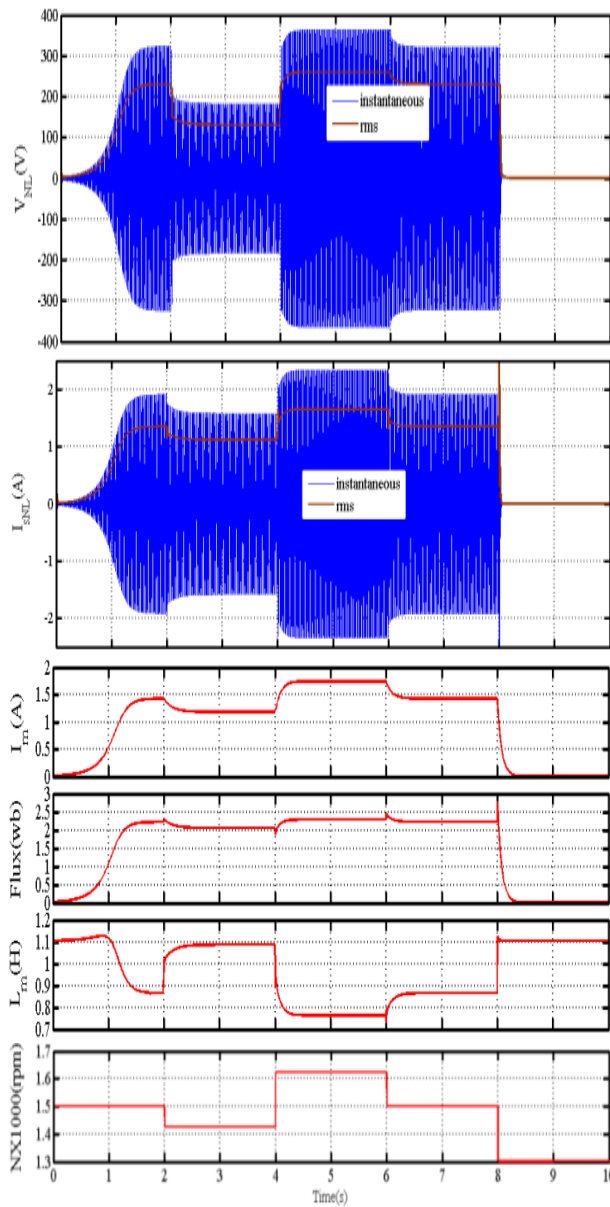

Fig. 2. variation of SEIG parameters with speed.

C. SEIG Performance with 0.9 Lagging pf Loading

Retaining the same set of optimum capacitances the rated load of 0.9 lagging power factor is switched to the SEIG terminals with $R_L=76 \Omega$ and $L_L=117 \text{ mH}$. The simulated loading transients and the waveforms of load voltage and currents are depicted in Fig. 3 and Fig. 4 respectively. Here, it is seen that the SEIG operating in short shunt connection is able to supply the connected load successfully. The full load voltage is about 375 V (265 V, rms) and the load current attains a value of 4.67A (3.3 A, rms).

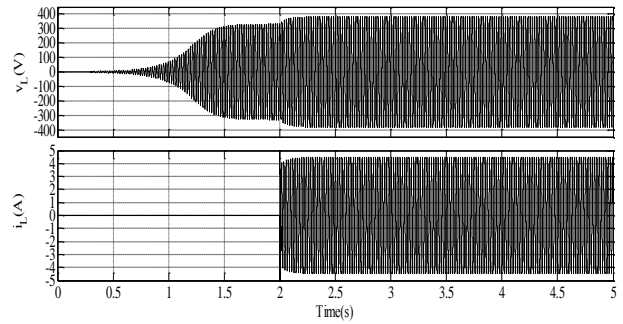
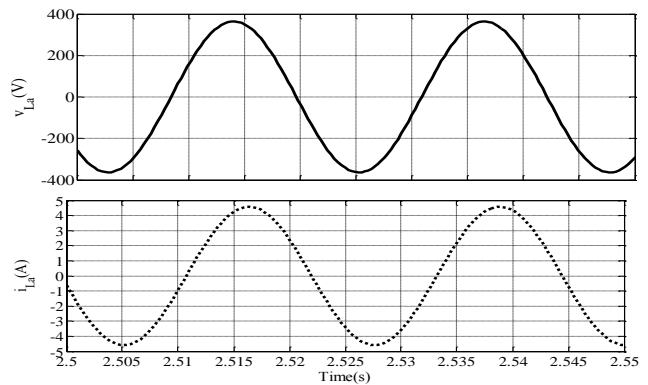

Fig. 3. Loading transients for voltage and current at full load of 0.9 lagging pf.



(a)

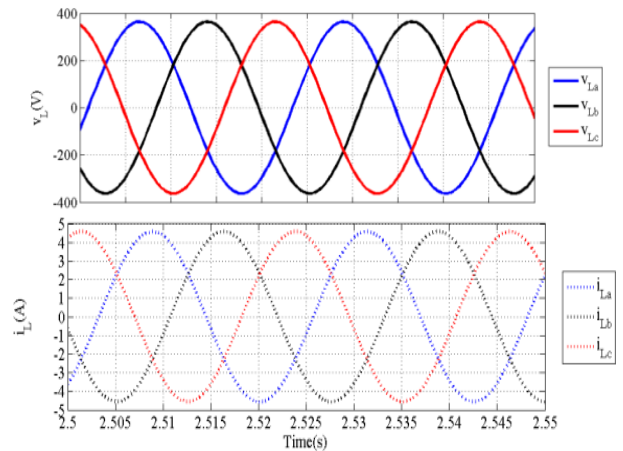

Fig. 4. Zoomed view of load voltages at 0.9 lagging PF (a) phase a voltage and current (b) all three phase load voltages.

The experimental results for the resistive–reactive (RL) loading considered for the simulation above are depicted in Fig. 5. It may be seen that load currents and voltages converge within $\pm 5\%$ with the simulated results. Moreover, the three phase load voltages and currents are observed to be quite balanced as is evident from Fig. 5 (c). The measured active, reactive and the active powers may also be seen in Fig. 5(d).

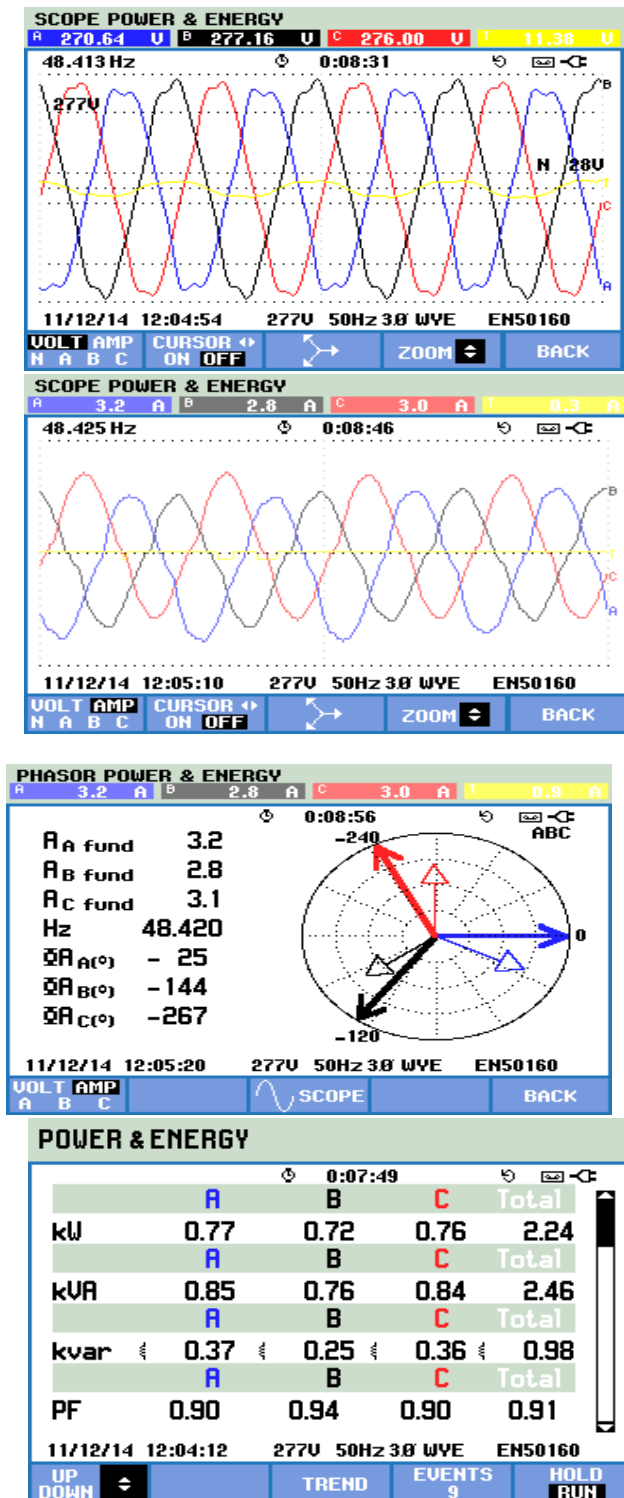

Fig. 5. Measured output parameters of SEIG at rated load of 0.9 lagging power factor (a) three phase terminal load voltages (b) three phase load currents (c) phasors of load voltage and currents (d) active, reactive and apparent powers and operational power factor.

IV. CONCLUSION

Mathematical modeling of a three-phase, self voltage regulating short shunt SEIG in stationary d-q reference frame is successfully demonstrated in this paper. The developed model is implemented in terms of a simulink model to carry out its no-load and on load analysis. The no-load results clearly show sensitivity of generated voltage to any transient change in driven speed. Subsequently, with the full load of 2.2 kW at 0.9 PF lagging being connected to the SEIG terminals, the SEIG is able to successfully withstand the loading and renders balanced output operation. The corresponding simulated and experimental results converge with 5% accuracy.

REFERENCES

- [1] L. A. C Lopes and R. G, Almeida, "Wind-driven self-excited induction generator with voltage and frequency regulated by a reduced-rating voltage source inverter," IEEE Trans. on En. Conv. , vol.21, no.2, pp.297,304, June 2006.
- [2] B. Thomsen, J. M. Guerrero, P. B. Thogersen, "Faroe islands wind-powered space heating microgrid using self-excited 220-kw induction generator", IEEE transactions on sustainable energy , vol.5, no.4, pp.1361-1366, Oct. 2014.
- [3] S. Kumar, N. M. Kumaresan, M. Subbiah, M. Rageeru, "Modelling, analysis and control of stand-alone self-excited induction generator-pulse width modulation rectifier systems feeding constant DC voltage applications", IET Generation, Transmission & Distribution, vol.8, no.6, pp.1140-1155, June 2014.
- [4] M.F. Khan, M.R. Khan, Analysis of voltage buildup and speed disturbance ride-through capability of a self excited induction generator for renewable energy application, International Journal of Power and Energy Conversion 7 (2016) 157-177.
- [5] Y. K. Chauhan, V. K. Yadav, B. Singh, "Optimum utilisation of self-excited induction generator", IET Electric Power Applications, vol.7, no.9, pp.680,692, November 2013.
- [6] M. F. Khan and M. R. Khan, "Wind Power Generation in India: Evolution, Trends and Prospects", International Journal of Renewable Energy Development, vol.2, no.3, pp. 175-186, 2013.
- [7] M. H. Haque, "A novel method of evaluating performance characteristics of a self-excited induction

generator,” IEEE Trans. Ene. Con., Vol. 24, No. 2, June 2009, pp. 358-365.

[8] M. R. Khan, M. F. Khan and A. Iqbal “Investigation on Resonating Behaviour of a Self Excited Induction Generator”, in the proceedings of IEEE Tencon-Spring 2013, 16-19 April’2013, Sydney, Australia.

[9] R. R., Chilipi, B. Singh, S. S. Murthy, “Performance of a self-excited induction generator with dstatcom-dtc drive-based voltage and frequency controller”, IEEE Transactions on Energy Conversion, vol.29, no.3, pp.545,557, Sept. 2014.

[10] K. L. V. Iyer, Lu Xiaomin, Y. Usama, V. Ramakrishnan, N.C. Kar, “A twofold daubechies-wavelet-based module for fault detection and voltage regulation in seigs for distributed wind power generation”, IEEE Transactions on Industrial Electronics, vol.60, no.4, pp.1638,1651, April 2013.

[11] P. J. Chauhan , J.K. Chatterjee, H. Bhare , B.V. Perumal, D. Sarkar, "Synchronized operation of dsp-based generalized impedance controller with variable-speed isolated seig for novel voltage and frequency control”, IEEE Transactions on Industry Applications, vol.51, no.2, pp.1845,1854, March-April 2015.

[12] M. F. Khan and M. R. Khan, "Self regulating three phase-self excited induction generator for standalone generation," in Proc. IEEE INDICON 2013, pp.1-6, 13-15 Dec. 2013.

[13] M. F. Khan and M. R. Khan, , "Voltage control of single-phase two winding self excited induction generator for isolated loads," Advances in Energy Conversion Technologies (ICAECT), 2014 International Conference on , vol., no., pp.209,214, 23-25 Jan. 2014

IEEE Xplore doi: 10.1109/ICAECT.2014.6757089.

[14] Y. K. Chauhan, S. K. Jain and B. Singh , “A prospective on voltage regulation of self-excited induction generators for industry applications,” IEEE Trans. on Ind. Appl., vol.46, no.2, pp.720,730, March-april 2010.

[15] M.F. Khan, Modeling and control of multi-phase induction generator for wind energy applications, Ph.D. Dissertation, Aligarh Muslim University, India (2015).

[16] D. Seyoum, C. Grantham, M.F. Rahman, The dynamic characteristics of an isolated self-excited induction generator driven by a wind turbine, IEEE Transactions on Industry Applications 39 (2003) 936-944.

[17] G. B. Shrestha, M. H. Haque, “AC circuits and Machines”, Singapore: Prentice-Hall, 2006.

[18] L. Kalamen, P. Rafajdus, P. Sekerák, and V. Harbovcová, “A novel method of magnetizing inductance investigation of self-excited induction generator,” IEEE Trans. Mag., Vol. 48, No. 4, April 2012, pp. 1657-1660.

APPENDIX

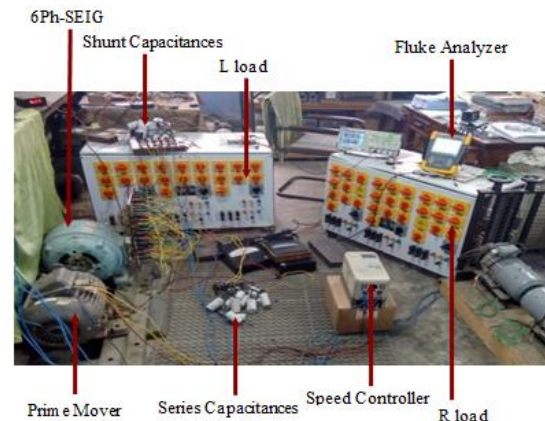

Fig. 6. Illustration of the 6Ph-SEIG test-rig.

SEIG Parameters

400 V, 3 hp/2.2KW, 5.5 A, $R_s=5.3 \Omega$, $R_r'=1.7 \Omega$, $X_{ls}=X_{lr}=5.45 \Omega$ open stator winding squirrel cage induction machine,

Prime Mover Parameters

3-phase, Delta connected, 415 V, 7.6 A, 3.7 KW, 1430 rpm, 50 Hz, Squirrel cage type induction motor.

Speed Controller

YASKAWA VARISPEED Inverter Drive 616G5, 3 phase, 400 V, 2.2 kW.

Socio-Economic Determinants of Sweet Melon Production in Balanga Local Government Area of Gombe State, Nigeria

^[1] Omorogbe I, ^[2] Aina OS, ^[3] Yakubu SA, ^[4] Hassan AA

Department of Agricultural Extension and Management, Federal College of Horticulture, Dadin-kowa, Gombe State, Nigeria

Abstract— The potentials of the horticulture sub-sector in solving the prevailing food crisis in Nigeria remain largely untapped because of inefficient use of production resources. The study examined socio-economic determinant of sweet melon production in Balanga local government area of Gombe state. A two stage sampling procedure was used in drawing a sample size of sixty sweet melon farmers from three communities. Data collected were analyzed using both descriptive and multiple regression models. The result revealed that the majority of the farmers were male, married, and literate, with small holding. A coefficient of multiple determinants, R^2 of 0.765 indicated a high relevance of the input in explaining the observed variation in melon production. The regression co-efficient of experiences, farm size and house hold size were significant at 5% level of probability, therefore, making the three factors important determinant of output from sweet melon production. Based on findings from the study, it is recommended that government should provide credit facilities with less bureaucracy and low interest rate to producers; this will enable farmers to increase their farm size and in turn increase output

Keywords: Socio-economic; Determinant; Sweet melon; Production; Balanga

I. INTRODUCTION

Sweet Melon (*Cucumis melon* L.) is a warm, long season horticultural crop that is adapted to all climatic zones. Annual world production of melon has increased from 9 million (700,000 ha) in 1992 to 22 million (1.2 million ha) in 2002. Major producing countries are China with 400,000 ha, West Asia (Turkey, Iran, Iraq) 200,000 ha, the America (United State, Mexico, Central and South American countries) 165,000 ha, Northern African (Egypt, Morocco, Tunisia 110,000 ha. Southern Asia (India, Pakistan, Bangladesh 100, 000 ha). European Union (Spain, Italy, France Greece, Portugal) 95,000 ha, Romania 50,000 ha Japan 13,000 ha and Korean republic 11,000 ha FAO [1]. Each country has its own specific melon cultivars of the crop which are sold in local markets. In Africa, it is an economic crop for urban markets, grown in drier region and non-high lands. Statistics on production and marketing in Africa are not available for most countries except Cameroon (3500 ha) and Sudan (1200 ha), Senegal and surrounding countries are exporting the melon during the winter to Europe FAO [1]. Mature fruits of sweet melon cultivars are usually consumed fresh for the sweet and juicy pulp. The pulp is also mixed with water and sugar or sometimes with milk, and served as a refreshing drink or made into ice cream. Immature fruits of non-sweet types, including snake melon are used as a fresh cooked or pickled vegetable. They can also be stuffed with meat, rice and spice, and fried in

oil. Sweet melon is often confused with cucumber and often used as such. The seeds are eaten after roasting they contain edible oil. The Hausa people in Nigeria grind the kernels to a paste and make it into fermented cakes. The young leaves are occasionally consumed as a pot herb and in soups. The leafy stem and also the fruit provide good forage for all livestock. In reunion and Mauritius a decoction of seeds and roots is used as a diuretic and vermifuge [2]. Sugar content and aroma are important factors determining the quality of sweet melon. Esters derived from amino acids are important components of the characteristics flavour, sulphur containing compound also play a role. Several C-9 alcohol and aldehydes, including Z-non 6-Enal, are characteristics of the melon aroma. To get the best aroma fruits should be harvested only 2-3 days before they are fully ripe. The edible seed kernel contains approximately 46% of yellow oil and 36% protein [3]. Given the increasing popularity and importance of sweet melon as a desert to many households in Nigeria, it is imperative to understand the problems facing the producers of sweet melon. Olukosi and Isitor[4] identified several possible factors that are constraints to production of fruit and vegetables. These include low farm gate price, high cost of labor input, inadequate supply of improve inputs and inefficient marketing system Due to the increasing demand and importance of sweet melon, venturing in to its enterprise holds promising potentials. However, there is little or no attention given to sweet melon production technology while only a few is done on its

marketing as well. Thus, there is need for further investigation into socio-economic determinants of sweet melon production in Balanga local government area of Gombe state and also determine the factors influence sweet melon production in the study area.

Problems of sweet melon production

According to Adamu et al. [5], in his studies of profitability of sweet melon production and marketing in Kirfi Local Government Area; Bauchi State shows that majority (87.5%) of the producers and marketers face the problem of transportation due to poor feeder roads, similarly (50%) and (62.5%) of the producers and marketers experienced inadequate capital to improve their productivity and farming business respectively. Moreover, 75% and 37.5% of the producers and marketers complained of glut (on-season problem) respectively. It is noteworthy that about 31.3%, 56.3% and 81.3% of all the producers complained of inadequate improved seeds, labor, disease attack as well as low farm gate price respectively. This indicated that water melon producers in the study area undergo the water melon business under unpredictable situation as was also reported by Singh [6], for vegetable and tomato producers in the semi-arid regions and Yamaltu Deba Local Government Areas of Gombe State, Nigeria. Similarly, other authors reported many problems that are limiting the fruit production as, Dieter [7], shows that in his report, fluctuation in the price of fruit also contributes a major problem in its business. Agricultural production has been increasing at (2%) two percent per year while demand has been increasing at slightly less rapid rates. This means that agricultural prices income have to be low. Similarly Adegeye and Dittoh [8], reported that prices of fruits and other agricultural produce are often manipulated by speculators with adverse effects on the producers and the consumers there is too much seasonal variation in price due mainly to lack of storage facilities and insufficient supply. Also according to the Abbott [9], shows that most fruit do not have adequate storage or ware housing facilities. The existing infrastructural facilities such as access roads, transport, market storage and processing are far from being adequate Singh [6]. Food processing plants are virtually none existing. These pose a serious problem for effectively processing of agricultural producers. Hence, affect the effective production of fruit and other agricultural produce. In the same studies carried by Adegeye and Dittoh [8], also reported that some marketing problems can be traced to lack of information about production, for example sellers may not be able to identify source of supply of commodities, while producers may curtail their production as a result of poor sales. Therefore, there must be an information system where buyer and seller can be aware of each other problems.

Also according to them, the problem of transport in marketing of fruit and vegetables has many dimension, in some cases there are insufficient vehicles to carry goods from farm (purchase place) to markets (serving places) and from rural market to the towns. In other cases, transport accounts for a large proportion of production costs. In some instances there are no roads where they exist they might be seasonal. Feeder roads are usually few and in most cases have to be construction and maintained by communal efforts. Adegeye and Dittoh [8] reported that all effort has geared towards producing more without thinking about how to market them. There is need to know about new technologies in food storage preservation and marketing. Thus, there is need for research on consumers demand and preferences, handling and packaging to reduce lose in fruit and vegetable as well as in other agricultural produce marketing.

Some of these problems reported by Singh [6] include:

- Problems of price variability.
- Inadequate processing and storage facilities.
- Lack of information about production and marketing.
- Lack of transport facilities.
- Lack of uniform weight and measures.
- Inadequate research on fruit market, etc.

II. METHODOLOGY

Area of the study

Gombe state was created on 1st October, 1996 by the military Government headed by General Sani Abacha, the commander-in-chief of Armed forces of the federation. It was formally under Bauchi state. The state has eleven local government councils with its administrative headquarters in Gombe. Gombe state shares common boundary with Borno state in the east, Bauchi state by the west, Yobe state by the north and Adamawa state by the south. It is located in latitude 10°15' north and longitude 110 east. Her population is estimated of 1.5 million covering the area land mass of about 20, 265 square kilometer [10]. The area of the study was Balanga Local Government and it has covered three distinct areas in the local government namely, Maidara, Daban Magarya and Bakasi. The study area is located in co-ordinates 9°58'N 11°41'E. Balanga is a local government area in the south east of Gombe State, Nigeria bordering Adamawa State. It's headquarters Talasse. It has an area of 1,626 Km² and a population of 212,549 at the 2006 census. The climate condition of the local government area is characterized by two distinct seasons, dry and wet. The hottest months are March and April which recorded up to a temperature of about 40-42°C while the

coldest months are December to February with a minimum temperature of about 20-22°C and the area received the mean annual rainfall of 321.4 mm/annum [11]. Sample procedure and sample size The data for this study were generated through the use of structured questionnaire complemented with data were collected from sixty sweet melon producers in Balanga local government area of Gombe state. Purposive sampling technique was used to select three villages and proportional sampling was used in selecting twenty respondents from each village. Twenty questionnaires each were administered to sweet melon producers in Maidara, Daban Magarya and Bakasi. The data were collected by the researcher with help of two well trained personnel's within the period of eight weeks, beginning from June-July 2015.

Method of data analysis

The statistical tools employed in this study include descriptive statistics analysis, such as frequency distribution, percentage and mean were used for the analysis of socio-economic characteristics of sweet melon producers. The relationship between the socio-economic characteristics and production of sweet melon was determined using multiple regressions model. The model was specified as:

$$Y=f(X_1,X_2,X_3,X_4,X_5,X_6,X_7,X_8,u)$$

Where,

Y=Output in Pyramid/Bill (Kg)

X1=Age (Years)

X2=Years of Experience (Years)

X3=Farm Size (Ha)

X4=Household Size (No. of Person)

X5=Level of Education (Years)

X6=Marital Status (1=Married, others=0)

X7=Extension Contact (Yes=1, No=0)

X8=Membership of Cooperative (Yes=1, No=0)

U=Constant term

The above model was specified and estimated in four functional forms. The functional forms tried include the linear, exponential, semi-log and double-log. The functional form which gives the best fit in term of R² value was selected because it agree with a priori expectation.

III. RESULTS AND DISCUSSION

Socio-economic characteristics of sweet melon producers

Table 1 shows that majority (98.3) of the sweet melon producers in the study area were male. This implies that the participation of female in sweet melon production in the study area is very low. This agrees with the finding of Adamu et al., [5] who reported that males dominated the farming aspect of water melon in Kirfi Local Government Area of Bauchi State Nigeria. This is because most of the people in the study area are Muslims and "Purdah" is practice for female and house wives (not allowed in to farming) as enshrined in the culture of northern Nigeria. On marital status of the respondents, the results revealed that 95% of the sweet melon producers in the study area were married while only 5% were single in the study area. This is in line with study made by Atman et al., [12] which revealed that (98.99%) of vegetable marketers in Yamaltu Deba Local Government of Gombe State, Nigeria were married. This is because majority of the producers in the area were Muslims and their religion permits them to marry at early ages. It is clear from the table that majority of the respondents were in the age category of 31-45 years representing 61.7% followed by those within the range of 16-30 years with 20%, those within the range of 46-60 years represents 18.3%, none of the respondent fall within the age of 61-75 years. The result further shows that a minimum of 19 and maximum of 53 years was recorded with a mean ages of the producers as 39 years, standard error of the mean was found to be 0.88% and 54.3% co-efficient of variability, implying that there is variability in the age of the respondents. The result depict that production of sweet melon in the study area are mostly carried out by relatively middle aged people. This category of people is believed to be more flexible in their decision making and adopt new ideas more readily, and the aged are risk-aversive. The results also indicated that 50% of the respondents attended Qur'anic schools, 23.3% had primary education, 16.7% had secondary education, while 8.3% had no formal education and 1.7% had attained tertiary education. The literacy level among the respondents was relatively high. It is expected that the sweet melon producers in the study area could readily adopt new ideas of agricultural production and can make accurate use of production decision. This is in line with the study made by Atman et al., [12] which reported that literacy status of respondents is necessary to explain the strength or weakness observed in their management ability and adoption of innovation. Educations are an important tool in increasing adoption of improved farm practices and ultimately improve in farm production and productivity. On occupation of the respondents, the result indicated that 43.3% of the sweet melon producers in the study area were engaged in farming alone; 33.3% engaged in farming and

Socio-Economic Determinants of Sweet Melon Production in Balanga Local Government Area of Gombe State, Nigeria

trading/business. 8.3% were into farming and livestock rearing while, 8.3% were sweet melon producers and civil service, 6.7% of the respondents were engaged in farming and others artisan activities such as driving, mechanic and car washing. The result means that majority of the respondents were full time farmers in the study area. The results revealed that majority had between 11-15 and 16-20 persons in their

	Frequency	Percentage
Sex		
Male	59	98.3
Female	1	1.7
Marital Status		
Married	57	95
Single	3	5
Age		
16-30	12	20
31-45	37	61.7
46-60	11	18.3
Educational Level		
No formal Education	5	8.3
Quaranic Education	30	50
Primary Education	14	23.3
Secondary Education	10	16.7
Tertiary Education	1	1.7
Occupation		
Farming alone	26	43.3
Farming and Trading	20	33.3
Farming and Livestock	5	8.3
Farming and Civil Services	45	8.3
Farming and Artisanship	4	6.7
Household Size		
1-5	12	20
6-10	12	20
11-15	13	21.7
16-20	13	21.7
21-26	9	15
27-30	1	1.6
Years of Experience		
1-5	56	93.3
6-10	4	6.7
Farm Size		
0.5-1	29	48.3
1.5-3	31	51.7
Source of Finance		
Family and Friend	53	88.3
Bank Loan	4	6.7
Cooperative Societies	3	5
Cropping Pattern		
Intercropping	26	48.3
Sole Cropping	20	33.3
Both	14	23.4

Table 1: Socioeconomic characteristics of respondents (Source: Field Survey, 2015).

households, representing 21.7% each, Household size of 1-5 and 6-10 persons also had 20%. The mean households' size

of the respondents was found to be 13 persons with standard error of the mean of 0.25, and co-efficient of variability of 23.7%. The result clearly indicated that, the minimum number of persons in a household was found to be one with a maximum of 27 persons in the study area. The low variability among the household size is most likely attributed to polygamous nature in Northern Nigeria, similar to what was reported by Umoh [13] in Bauchi metropolis. The result also revealed that minimum year of experience was found to be 1 year with the maximum of 6 years. The mean years of experience of respondents was found to be 3.1 years, standard error of the mean value of 0.12 and the co-efficient of the variability of 28.7%. This means that majority of the producers in the study area had not stayed long in the business because the fruit production was newly introduced to the area. The result indicated that majority (51.7%) of the respondents had a farm size category of 1.5-3.0 hectares following by those in the category of 0.5-1.0 hectare representing 48.3%. The result further shows that a minimum of 0.5 and maximum of 3 hectares was recorded with mean hectares of 1.5, standard error (SEX) of 0.008 and co-efficient of variability (CV) was found to be 1.19%. This implies that the farmers have small-scale managed farms. Majority (88.3%) of the respondents sourced their initial capital through family and friends, 6.7% obtained their capital from bank loan while, only 5% obtained financial support from co-operative societies. This indicated, the only means of financing their business was through family and friends. This agrees with the findings of Atman et al. [12] who reported that, tomato producers and marketers were only financing their business through informal means that is through own savings, money lenders, family and friends), as none of the respondent's claimed to have obtained money for financing his business from government. The result indicated that majority (43.33%) of the sweet melon producers engaged in intercropping pattern while 33.33% of the respondents were engaged in sole cropping and only 23.33% were engaged in both sole and inter cropping. This is in line with the study by Yusuf et al., [14] which stated that the higher the number of crops in the mixture the less the profitability. Also Yusuf [15], discovered in his research on Egusi melon that the more the number of crops in the mixture the less the yield and the less the profitability, which he attributed to the competitive effects of the various crop in the mixture (Table 1).

Regression results for the socio-economic determinants of sweet melon production

Multiple regression analysis was used to determine the socio-economic factors influencing the sweet melon production in the study area. In order to compare and assess

Socio-Economic Determinants of Sweet Melon Production in Balanga Local Government Area of Gombe State, Nigeria

in detail the necessary parameters, four functional forms viz: linear, double-log, semi log, and exponential function were fitted to the data. The result presented in Table 2 shows the estimated impacts of socio-economic factor of respondent on production output (age, experience, farm size, house hold size, education attainment, married status). Double-log function was found to have the best fit and therefore chosen as the best lead equation. The R² of the double-log function was found to be 0.768. This implies that about 76.8% of the variation in output of the respondent was accounted for by joint action of the six independents factor while the rest 23.2% of the variation was due to error. The overall regression result was significant with F-statistic value of 35.717 at 5% level of probability. The regression co-efficient of experiences, farm size and house hold size were significant at 5% level of probability, therefore, making the three factors important determinant of output from sweet melon production. The other three factors age, education attainment and marital status were not significant and therefore, constituted weak determinants of production output. Farmers with high experience are more likely to produce more sweet melon than their counterparts with low experience, and also farmers with large farm size are more likely to produce more melon with their counterparts with small farm sizes and the farmers with large house hold size are more likely to produce more sweet melon than their counterparts with small household size which are similar to Ugwumba [16].

IV. CONCLUSION

The study was conducted in Balanga Local Government Area, Gombe State. The main objective of the study is to obtain information

Factors	Linear Function	Semi-Log Function	Double-Log Function	Exponential Function
Constant	338.245 (0.269)	670.601 (1.223)	3.617 (10.479)**	3.071 (35.889)**
Age	-0.110 (-0.780)	-0.186 (-1.073)	-0.168 (-1.409)	-0.86 (-0.825)
Experience	0.519 (4.780)**	0.463 (3.846)**	0.583 (7.065)**	0.598 (7.419)**
Farm Size	0.312 (2.752)**	0.362 (2.839)**	0.317 (3.625)**	0.245 (2.909)**
House Hold Size	0.158 (1.249)	0.155 (0.869)	0.268 (2.191)**	0.256 (2.734)**
Education Attainment	0.009 (0.097)	0.030 (0.312)	0.025 (0.382)	0.013 (0.185)
Marital Status	-0.005 (-0.045)	-	-	0.68 (0.831)
F-Statistic	11.070**	11.109**	35.717**	27.361**
R _i	0.556	0.507	0.768	0.756
R _i Adjusted	0.506	0.461	0.746	0.728

Table 2: Regression results for the socio-economic determinants of sweet melon production

on socio-economic determinant of the respondents, in achieving these objectives; three villages (Maidara, Daban Magarya and Bakasi Areas) were purposively selected. Sixty respondents were randomly selected from the list frame of the sweet melon farmers. The respondents were issued with questionnaires, which were filled with the help of well trained enumerators and the researcher. Statistical tools such as descriptive statistics and multiple regression analysis were used in data analysis. The major findings of this study revealed that the majority of the sweet melon producers were male, married and were within the age bracket of 31-45 years with mean age of 39 years. The result further showed that the respondent had one form of education or the other with Qur'anic education as the highest up to 50%, and had 1-5 years experience with the mean 3.1 years of experience. Moreover, the result also showed that 43.3% of the respondents engage in farming alone and mainly sources their initial capital for the business through family and friends been (88.3%). The regression analysis of the socio-economic characteristics show that double-log regression was chosen as the lead equation based on the values of R² of 0.768 with a standardized co-efficient of 0.256. The regression co-efficient of experiences, farm size and the house hold size were significant at 5% level of probability, therefore, making the three factors important determinant of output from sweet melon production.

V. RECOMMENDATION

Based on the findings the following recommendations were made:

1. Socio-economic characteristic of sweet melon farmers should be taken into consideration when formulating policies and also when introducing new technologies to rural farmers.
2. Provision of credit facilities with less bureaucracy and low interest rate to producers. This will enable farmers to increase their farm size and in turn increase their output.
3. Extension agent should be mobilized in the area to enhance the level of agronomic practices of melon farmers. Access to extension agents enhances the chances of having access to better crop production techniques, improved inputs as well as other production incentives and in turn leads to increase in output.

REFERENCES

Socio-Economic Determinants of Sweet Melon Production in Balanga Local Government Area of Gombe State, Nigeria

1. Food and Agriculture Organization (2000) Food and Agricultural Organization of the United Nations in: AO (1990). Assessing Agricultural Commodity Price Variability, Economic Research Services/USDA Risk Management, p: 16.
2. Makhura MT (2002) Overcoming the Transaction Cost Barriers to Market participation of Smanholder Farmers in the Northern Province. University of Protein, Pretoria.
3. Wyllie SH, Leach DN, Wang YM, Shewfelt PL (1995) Key Aroma Compounds in Melons: Their Development and Cultivar Dependence. In: Rousseff RL and Leahy MM (eds.) Fruit Flavours: Biogenesis, Characterization and Etherification. Am Chem S, Washington DC, USA, pp: 248-257.
4. Olukosi JO, Isitor SU (1990) Introduction to Agricultural Production Economics: Principels and Applications. Agitob Publishers Ltd., Zaria, p: 112.
5. Adamu Y, Hamidu K, Mahmoud BA (2011) Profitability of water melon marketing in Kirfi Local Government Area of Bauchi State, Nigeria. Paper presented in the preceding of the 25th Annual national Conference of Farm Management Association of Nigeria.
6. Singh BR (2004) Constraints to Sustainable Crop Production in Semi and North West of Nigeria. The Nigerian J Agr Rural Manag 7: 40-62.
7. Dieter E (1985) Agricultural Marketing Policies and Development: Agricultural marketing Strategy and Pricing Policy, pp: 5-12.
8. Adegeye AJ, Dittoh (1985) Essentials of Agricultural Economics. Published by Impact Publichser, Nigeria Limited Ibadan, pp: 164-181.
9. Abbot JC (1985) Marketing Problems and Improvement Programmes FAO, Rome, pp: 1-14.
10. National Population Commission (2006) National Population Report, Abuja, Nigeria.
11. Gombe State Metrological Station (2012) Bulletin, pp: 11-13.
12. Atman FM, Haruna U, Sani RM (2008) Profitability of tomato production and marketing in Yamaltu Deba LGA of Gombe State, Nigeria. 9th Annual Nation Conferences of Nigeria Association of Agricultural Economic Proceeding.
13. Umoh GS (2006) Resource use Efficiency in Urban Farming. An Application of Stochastic Frontier Production Function. Int J Agr Biol 8.
14. Yusuf O, Sanni SA, Ojuekaiye EO, Ugbabe OO (2008) Profitability of "Egusi" Melon (*Citrullus Lanaltus Mansf*) Production Under Sole and Mixed Cropping Ssytems in Kogi State Nigeria. Asian Research Publishing Network (ARPN), J Agr Biol S 3: 14-18.
15. Yusuf O (2005) Economic Analysis of "Egusi" Melon Production in Okehi Local Government Area of Kogi State. Department of Agricultural Economics and Rural Sociology Ahmadu Bello University, Zaria.
16. Ugwumba COA (2010) Resource use Efficiency and Determinants of Cat Fish Production Output in Anambra State, Nigeria.

“Smart Dust” & Internet of Things (IoT): Progress & Challenges

^[1] Devendra K Sadana, ^[2] Ning Li, ^[3] Stephen W Bedell, ^[4] Ghavam S Shahidi
TJ Watson Research Center, Yorktown Heights, NY, USA

I. INTRODUCTION

The breath taking progress in CMOS scaling over last five decades has made it possible to shrink complex digital integrated circuits (ICs), such as a microprocessor into dimensions that are approaching a dust particle (<1 mm). For example, the latest 10 nm CMOS product is expected to have ~ 100 million transistors/mm² (1). This makes fabrication of highly advanced smart dust equipped with a low-power (μ W) micro-processor a reality and at a cost of less than a dime! Such unimaginable cost reduction is achievable because a 300 mm Si wafer can easily accommodate over 100,000 advanced ICs on a foot print of <0.8 mm \times 0.8 mm. This allows the recent emergence of Internet of Things (IoT) to be expanded using the “smart dust”. Continued proliferation of IoT is expected to exploit advances in smart dust and low-power wireless communication technologies in conjunction with progress in data security. The impact of IoT in monitoring and controlling various environments, such as agricultural fields, medical, healthcare, manufacturing plants, transportation systems and sending continuous streams of accurate and real-time data can be truly transformational (Figures 1 and 2).

The market potential of IoT is phenomenal as shown in Figure

1. It is expected that 10s of billions of devices will be connected for IoT related applications within next 3-5 years. Even more impressive will be the impact of IoT on transactional business as a whole. There are several projections from very respectable sources (IDC, CISCO, Goldman Sachs, McKinsey) which indicate that the overall market for IoT will grow at a 12.5% CAGR from over a \$1 trillion in 2013 to several trillions by 2020 (Figure 2).

One key challenge, however, for IoT technology is the security of the transferred and received data, and its authentication. This is the hot topic of IoT research today. The most sought after implementation of data security aims

at incorporating encrypted authentication and security software in the IoT device itself. In addition to security challenge, the ubiquity of smart dust or IoT in our daily lives will rely on breakthroughs in wireless communication and powering of ICs at ultra-low power (in the μ W range). There are two main technologies for wireless communication: (i) radio frequency (RF) based, and (ii) a.

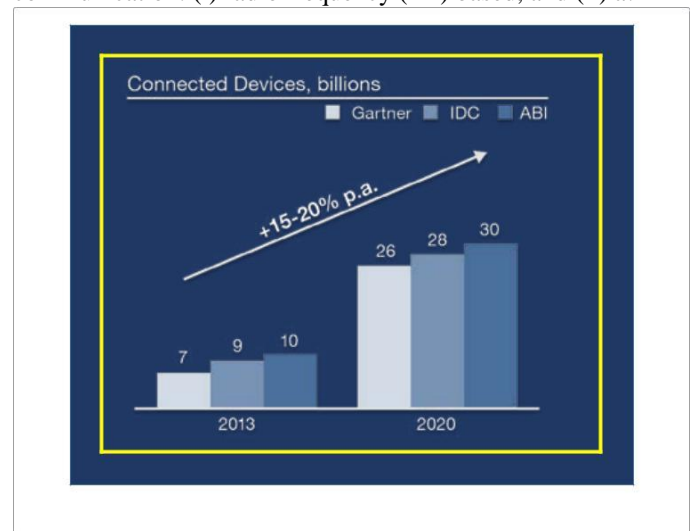

Figure 1: IoT to connect billions of devices

light source based. In this editorial we discuss pros and cons of both of these communication approaches.

RF Communication

RF transceivers are attractive for IoT because these do not require a direct line of sight for communication unlike their counterpart optical transceivers. However, RF circuits are typically larger than those which are optics based and operate at power levels in the multi-milliwatt range with a relatively large foot print (a cm or greater). Connectivity among large numbers of smart dust for IoT application by RF may further require additional circuitry for time, frequency or code-division multiplexing which will lead to even higher power consumption. Since the typical size of a RF antenna is relatively large (should be at least be a good fraction of the carrier wavelength), use of very short wavelengths/ high frequencies (75-100 GHz) may be

compatible with the smart dust dimension. However, in this frequency regime, RF communication will consume higher power. Furthermore, a smaller antenna will reduce both the RF communication sensitivity as well as its energy efficiency.

Optical Communication

Optical interconnects are becoming indispensable in state-of-the-art data centers for providing high band-width data transfer (10s of Gb/s) between and within servers at lower power than electrical connections for distances longer than a few centimetres. The optical transmitter and receiver technologies developed for data centers can

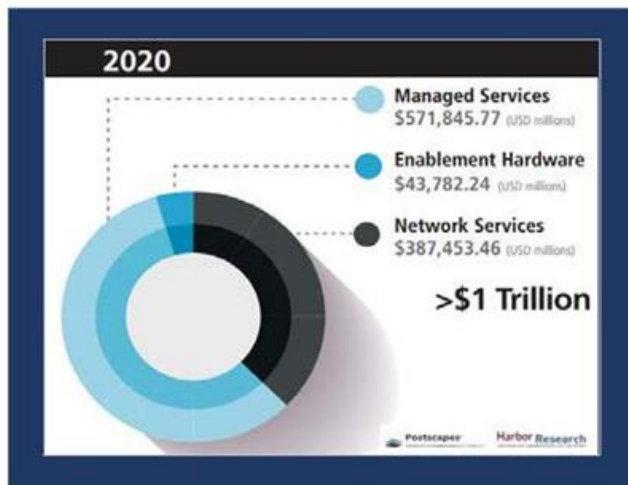

Figure 2: IoT to create trillion dollar market

also benefit the development of optical communication for smart dust devices. In particular, connectivity among a large body of tiny (<1 mm) smart dust or IoT devices distributed in free space via ultra low-power optical communication can be a game changer. Compared to RF devices, semiconductor lasers, LEDs, and detectors require a relatively small foot print (<1 mm) to transfer and detect optical signals and are more amenable to low-power operation (<1 mW). In optical communication, 1 GHz frequency can be easily obtained from a sub-millimeter aperture, whereas RF communication may require several inches long antenna to produce collimation for a 1 GHz radio frequency signal. Furthermore, optical transceivers require relatively simple baseband analog and digital circuitry. The short wavelength (400-800 nm) laser makes a sub millimeter-scale device capable of emitting data via a narrow beam at the μW power level. LEDs can be made much smaller [1-3]. Also, a compact imaging receiver may be sufficient to decode simultaneous transmission from a large number of IoT devices distributed at different locations. Despite its low power and small foot print requirements, optical communication in free-space has two major challenges to overcome: (i) line of sight communication, and (ii) narrow

beams for accurate pointing. Development of clever technologies and algorithms are required for smart dust/IoT applications to live up to their true potential to impact many aspects of our lives.

Energy Harvesting

Successful implementation of smart dust/IoT technologies requires autonomous, on-board energy harvesting. The most effective method for energy harvesting is based on solar cells, especially if smart dust/IoT devices are distributed in an outdoor environment [4]. These cells can be engineered to generate requisite power (μW to mW) on a target foot print by using high efficiency solar cells based direct band gap III-Vs. If an application requires smart dust/IoT devices to remain in dark or in low-light environment, power can be generated by shining light on the solar cell by an external light source of an appropriate wavelength. Storage of the energy generated by a solar cell attached to the smart dust/IoT devices requires an efficient micro-battery. Achieving high storage capacity, e.g., 1 mAh, in a foot print of <1 mm \times 1 mm for low-cost IoT devices is extremely challenging and has been the subject of active research. The front up approach for energy storage currently focuses on the Li-ion based solid state battery with high volumetric energy density [5]. This topic is rather broad in scope and will be discussed in a future editorial.

Summary

Spectacular progress has been made in the last decade to establish infrastructure for design and fabrication of IoT/smart devices addressing a multitude of applications including agricultural, medical, manufacturing, and pharmaceutical and many others. The economic impact of IoT once fully exploited for the real-time acquisition and analysis of data will be in trillions of dollars. However, there are two key challenges yet to be overcome: (i) developing a high energy density micro-battery that is capable of providing sufficient power on a few hundred microns foot print to enable various communication protocols for duration of several hours, and (ii) an efficient, low power optical and/or RF communication system that can overcome the line-of-sight limitation.

REFERENCES

1. Mistry K, (2017) 10 nm technology leadership: Leading at the edge technology and manufacturing day.
2. Want R, (2006) An Introduction to RFID Technology. IEEE Pervasive Comp 5: 25-33.
3. Song Y, (2002) Optical Communication for Smart Dust.

Virginia Polytech Inst.

4. Green M, (1986) Solar Cells: Operating Principles, Technology and System Applications.

5. Sun C, Liu J, Gong Y, Zhang J, Wilkinson DP (2017) Recent advances in all-solid-state rechargeable lithium batteries, Nano Energy 33: 363-386.

An Approach to Measure Similarity of Software Projects at the Design Phase

^[1] Asif imran

Institute of Information Technology, University of Dhaka

Abstract:-- Estimation of software comparability is one of the ideal approach to utilize experiences of effectively developed software. Experiences obtained from previous projects can help software industries to deliver software project in a short period of time. Although various approaches have been proposed throughout years on software similarity that helps to utilize the previous projects knowledge, none of these are based on design diagrams. However, research on measuring software similarity based on design paradigm is expected to use the historic projects knowledge in early phase of software development. This paper proposes an approach of measuring similarity by developing a tool named Software Design Similarity Measurement Tool (DeSiMeT). DeSiMeT ascertains a similarity score between two software projects utilizing class diagram, sequence diagram and state transition diagram. An experimental analysis has been conducted by running the tool using seven software projects to verify the approach. The analysis of the tool appears in a precision of 0.83, recall of 1 and F-measure of 0.91 which concludes that the tool performs well as a novel work.

Index Terms—Software Similarity, Historic Project, Software Design, Class Diagram, Sequence Diagram, State Transition Diagram

I. INTRODUCTION

In today's fast changing business environment, software industries attempt to rapidly develop their products so that they can speed up the delivery of their latest innovations to customers. This makes software development more challenging as software developers need to design, implement, and test complex software systems as early as possible. As a result, software companies are in search of some solutions that can help to deliver good quality and error free software in right time. Experiences obtained from historic projects can help software industries to adopt shorter release cycles. In this regard, measurement of software similarity is one of the best way to use experiences of already developed software [1]. Proper identification of similar software helps to select development methods, design patterns and reliability testing models as well as is applicable in the areas of data mining, software testing, plagiarism detection and software security [2]. This helps software industries to decrease their efforts, costs and time of development cycle [3].

In this research, a method to measure similarity between software projects were proposed based on software design paradigm. The proposed method computes similarity between intended software project and historic software projects to use previous knowledge. More precisely, the problem can be addressed by the following questions:

- How to utilize the experiences of historic software

Here, we use design paradigms of different projects to

measure similarity among those. The proposed method solely focuses on the quantitative similarity measure. For this purpose, we use different design diagrams i.e. class diagram, sequence diagram and state diagram. To measure similarity score, a tool named Software Design Similarity Measurement Tool (DeSiMeT) is developed.

II. RELATED WORK

In the software engineering literature, a less work has been done that addressed the issue of measuring similarity between two software projects. Some works have been done based on fuzzy logic, Euclidean Distance, Graph Matching and Source code corresponded but these are not enough to solve the existing problems. Two approaches for measuring similarity between software projects based on fuzzy C-means clustering and fuzzy logic were presented in [7]. The proposed approaches overcame the problems of nearest neighborhood techniques. First approach was developed based on identification features of fuzzy sets and second approach was based on partition matrix that is obtained by fuzzy C-means. They stated that first approach outperforms second approach based on some experimental results. This approach is not applicable for linguistic values and only suitable for numerical and categorical data. Some specific research has been done for computing difference between class diagrams. A generic difference algorithm proposed for computing similarity of two UML models which were encoded in XML files from design diagram [14]. The implemented algorithm performed well on runtime for small documents but not good for a large documents. A

comparative result were presented using basic graph by denoting node and edge. In this approach, at first the elements of each document were detected and then calculated similarity by a defined function that worked with some predefined criteria. Weight was defined for each criteria in a way that may mislead to a missed correspondences. To optimize cost-resource for cloud environment an empirical analysis investigation was proposed in [13]. Authors presented a comparison analysis between open source cloud and organizational cloud to increase the performance of open source cloud by optimizing cost and resource. However, performance, of open source cloud can be enhanced by applying software similarity approach to find out the best result. Although various approaches have been proposed throughout years, none of these are based on design diagrams. However, research is expected to use the historic projects knowledge in software development. In this research, we mainly focused on the design phase of SDLC.

III. PROPOSED APPROACH

The novelty of this research is to measure similarity of software projects based on some design diagrams in the design phase of SDLC. Firstly, in order to measure design similarity, we consider several design diagrams: (a) Class Diagram (CD) (b) Sequence Diagram (SD) and (c) State Transition Diagram (STD). These diagrams cover the overall design of any object oriented software project to the maximum extent. Later on, the diagrams are parsed by an open source automated tool i.e. StarUML and converted to XML format. Then the XML files are parsed by XML parser and compared using the structure and some comparison criteria. To demonstrate the approach, we have developed a tool and named it as Software Design Similarity Measurement Tool (DeSiMeT).

A. Overview of DeSiMeT

Top level view of the proposed tool's architecture is shown in the Fig. 1. The tool developed in a way that measured similarity between current project and historic project based on design diagrams those are declared in the previous section. Selected design diagrams are converted to XML format using an open source converter as the tool takes XML file as input.

B. Similarity Measurement Approach

Main purpose of this research is to find out the best similarity match of a current project with some historic projects. The proposed approach to measure similarity between software projects based on design depends on different UML diagrams which describe the external behavior of a project.

a) Structural Matching: In the view of a class diagram,

the whole system can be compared by relationships of classes. At first, class diagrams of a system are converted to XMLs and inputted to the tool. Then elements are parsed by an XML parser to proceed the next step. Class diagrams are considered as a graph where classes are denoted as node and relationships are denoted as edge.

($A \xrightarrow{Ag} D, A \xrightarrow{As} C, B \xrightarrow{Ag} C, D \xrightarrow{As} C, D \xrightarrow{G} E$ and $C \xrightarrow{As} E$)

Historic class also contains five classes and relation among the classes are:

($B \xrightarrow{Ag} A, B \xrightarrow{As} C, A \xrightarrow{Ag} C, A \xrightarrow{G} G, A \xrightarrow{G} F$ and $C \xrightarrow{As} F$)

b) Criteria Matching:

In the view of class each of the classes a similarity can be measured by comparing some criteria that is presented by Kettle et al. [14]. Due to the generic approach a function is defined by setting some criteria i.e. number of operations and number of attributes. In every case, graph matching can not provide accurate similarity score. Thus, quantitative value need to be considered as an important fact of measuring similarity of class diagram. A criteria matching algorithm is developed that is shown in Algorithm 2. For measuring criteria similarity, a class of first diagram is compared with all of the classes of the second diagram and stored. The same class can not be matched with any other class of the second diagram. The criteria similarity score is Ncalculated (Algorithm 2 Line 19). Finally, the total similarity between two class diagrams are measured by integrating the score of structural matching and criteria matching.

Algorithm 1 Structural Matching

```

1: input: XMLs (CD, SD, STD)
2: output : finalScorestructural
3: initialize mat[u][v] ← 0
4: initialize setofrelations ← R
5: for edges(u, v) in diagrams do
6:   mat[u][v] ← getValue()
7: end for
8: procedure GETVALUE
9:   if relations ∈ R then
10:    setValue = value
11:   end if
12: end procedure
13: finalScorestructural ← matchBFS()

```

1) Similarity of Sequence Diagram: SD is used to show the interaction among the objects in a given scenario based on a time sequence. It is a logical view of a system under development that is typically associated with the use cases. A sequence of messages are exchanged among the

participating instances through the interactions of the system and some actors or different subsystems or classes [17]. Sequence diagram is considered as a part of project to measure similarity as it represents the dynamic interactions of classes in execution [11]. Similarity measurement of sequence diagram is similar as class diagram using two phases such as :structural matching and criteria matching. The phases are described in the following sections.

a) Structural Matching: For structural matching, sequence diagram is also considered as a graph to measure similarity like class diagram. At first, the UML sequence diagrams of the system are converted to XMLs and inputted to the tool. The XMLs are parsed by the XML parser and a n n matrix is generated like class diagram. The lifelines are considered as node and sendMessage and replyMessage are considered as edge of the graph for generating matrix. Fig. 3 presents a sample example of sequence diagram and fig. 4 presents the generated matrix of fig. 3. For generating matrix, the values of edges are set as prime number to keep track the multiple call between two lifelines. Different values are set for sendMessage and replyMessage where sendMessage is defined by 2 and replyMessage is defined by 3 because these two edges are not same and address a different meaning for sequence diagram. Generated matrix is compared by the same algorithm that is used in class diagram is presented in Algorithm 1. The algorithm describes that all matrix is generated (Algorithm 1 Line 6). Value of edges are set based on message type between lifelines (Algorithm 1 Line 9-10). Similarly, for measuring similarity between two matrices of

sequence diagram, a customize Breath First Search algorithm is used (Algorithm 1 Line 13) that is proposed by smith et al. [20]. b) Criteria Matching: Criteria matching of sequence diagram is a statistical similarity measured based on some criteria i.e. number of lifelines, number of sendMessage and number of replyMessage. Algorithm 2 is used to measure criteria matching like class diagram. However, a function is defined for this purpose and a sequence diagram from first project is compared with all of the sequence diagram of the second project and store the max value. If a match is found in the next step then it is ignored as it is already compared. Then, the similarity score is calculated (Algorithm 2 Line 19). Finally, similarity of sequence diagrams are measured by integrating the score of structural matching and criteria matching.

2) Similarity of State Diagram: STD describes the behavior of a system using states of the system and transitions between states [18]. It shows different states of an entity as well as how an entity respond to events by changing the states. Similarity of state diagram is measured into two phases like class diagram.

a) Structural Matching: State diagram is considered as a graph to measure similarity where the states are considered

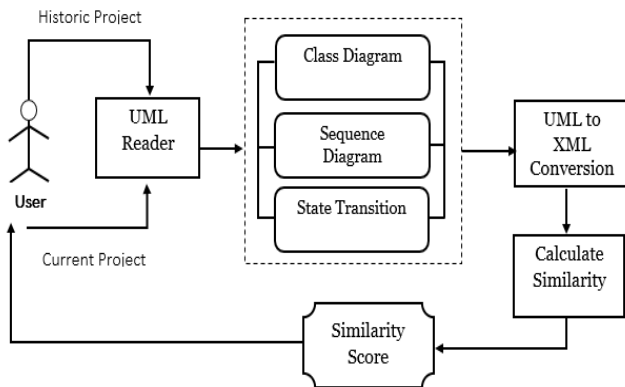

Fig. 1: Overview of Framework DeSiMeT

	A	B	C	D	E		B	C	A	G	F
A	0	0	2	5	0	B	0	2	5	0	0
B	0	5	0	0	0	C	0	0	0	0	2
C	0	0	0	0	2	A	0	5	0	3	3
D	0	0	2	0	3	G	0	0	0	0	0
E	0	0	0	0	0	F	0	0	0	0	0
	Current Project						Historic Project				

Fig. 2: Generated Matrices of Fig. 2

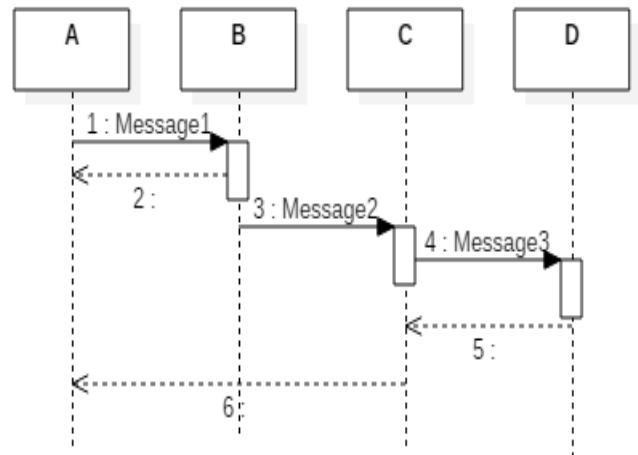

Fig. 3: Example of Sequence Diagram

	A	B	C	D
A	0	2	0	0
B	3	0	2	0
C	3	0	0	2
D	0	0	3	0

Fig. 4: Generated Matrix of sequence diagram

as node and transitions are considered as edge of the graph. At first, the UML state diagrams of the system are converted to XMLs and inputted to the tool. Then, the XMLs are parsed by the XML parser and a n n matrix is generated like class diagram. The value of edges are set as: start state to

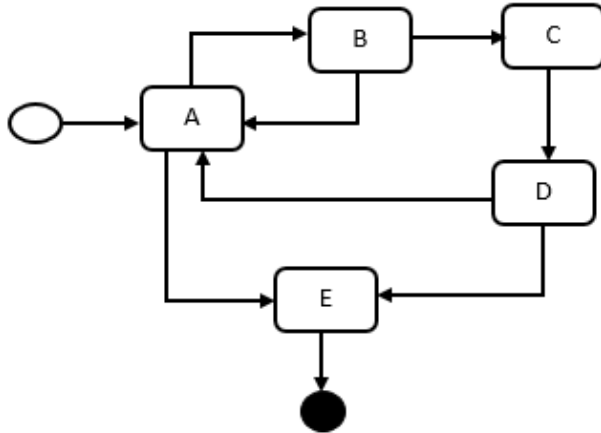

Fig. 5: Example of State Diagram

general state is defined by 1, general state to general state is defined by 2 and general state to final state is defined by 3. Algorithm 1 is also used for structural matching of state diagram. Similarly, for generating matrix the function is used (Algorithm 1 Line 6). The value of edges are set based on transition type between state that is shown (Algorithm 1 Line 9-10). The matrices are compared like class diagram that is used (Algorithm 1 Line 13).

b) Criteria Matching: Some criteria i.e. number of states, and number of transitions are defined for measuring the statistical similarity of two state diagrams. A function is defined based on these criteria and the similarity is computed using the algorithm 2 like other two diagrams. However, a state diagram from first project is compared with all of the state diagram of the second project and store the max value. If a match is found in the next step then it is ignored as it is computed. The similarity score is calculated (Algorithm 2 Line 19). Then, the similarity of state diagrams are measured by integrating the score of structural matching and criteria matching. Finally, total similarity score of two projects is calculated by integrating the similarity score of class diagram, sequence diagram and state transition diagram.

IV. CASE STUDY

The goal of this case study is to evaluate approximation of the proposed approach. The experiment have been conducted on some design diagram of software projects. A tool DeSiMeT has been implemented in java for this purpose.

A. Dataset

The analysis was performed on 7 different software project requiring different diagrams those are used in this research. These projects have been collected from the student of Institute of Information Technology, University of Dhaka. These projects are Inventory Management System (IMS), Student Management System (SMS), AmaderChakri.com (AC.com), Program Office Management System (POMS), Library Circulation System (LCS), Cricket Circle (CC) and Cloud Portal(CP). The project set is converted to XMLs using StarUml before running DeSiMeT as it takes XMLs as input. Table I shows the dataset in details. Project name, number of classes in class diagram, number of sequence diagrams and number of state diagrams of each project are presented in this table.

B. Study Result

For experimental result, dataset projects were run using DeSiMeT. The similarity score was measured between current project and historic project. In the dataset, IMS is the selected as current project and other projects as historic projects. For each historic projects, similarity values of class diagram, sequence diagram and state diagram were measured by comparing with current project that is presented in Table II. Here, first column presents the current project and second column presents historic project. Similarity values of Class Diagram (CD), Sequence Diagram (SD) and State Transition Diagram (STD) are also presented that were obtained from DeSiMeT. In the last column, similarity score of two projects are presented that is calculate d from the average value of CD, SD and STD.

C. Analysis

For the justification of DeSiMeT, an empirical analysis was performed. Table III presents the expected result and actual result of this tool. The expected similarity result was identified from a manual analysis that was performed by some software design experts. The actual result was generated from DeSiMeT and the similar project were chosen based on a threshold value that is greater than or equal 0.6 (threshold 0:6).

TABLE I: Result Analysis

CP	HP	Actual Result (threshold ≥ 0.60)	Expected Result
IMS	SMS	Yes	Yes
	AC.com	Yes	No
	POMS	Yes	Yes
	LCS	Yes	Yes
	CC	No	No
	CP	No	No

Now, from the actual and expected result that is shown in the table III, the precision and recall of DeSiMeT can be measured. Let, tp =true positive, fp =false positive, fn =false negative. From Table I, $tp = 5$, $fp = 1$, $fn = 0$. Thus,

$$Precision = \frac{tp}{tp + fp} = \frac{5}{5 + 1} = 0.83$$

As, DeSiMeT provides 1 false negative result, it possesses the maximum recall. Using the precision and recall, the F-measure or the balanced F-score (F1 score) can be calculated.

$$F_1 = 2 \cdot \frac{Precision \cdot Recall}{Precision + Recall} = 2 \cdot \frac{0.83 \cdot 1}{0.83 + 1} = 0.91$$

V. CONCLUSION

In this paper, a generic approach for measuring similarity between software projects is proposed. The approach is based on a series of design diagrams those are converted to XMLs. One of the challenges to measure similarity between complex types which are represented by XML, is handled by different techniques for getting the best scores as described previously. The task is performed in three steps: similarity of class diagrams in first step, similarity of sequence diagram in the second step and similarity of state diagram in third step are measured. A prototype tool DeSiMeT is developed to prove the feasibility of the approach. A case study is presented that evaluates the applicability of the approach. In this case study, seven projects were selected to perform the empirical study. For DeSiMeT, the precision, recall and F-measure were calculated that possesses a precision of 0.83, recall of 1 and F-measure of 0.91. The result shows that the proposed approach performs well as a novel work. In this approach, only three UML diagrams are considered for similarity Measurement, in future more diagrams will consider for performing better result. This work directs to our next work to software reliability model selection based on similarity score between current project and historic project.

REFERENCES

[1] Zeng, Jintao, et al. "A prototype system of software reliability prediction and estimation." in proceedings of the Third International Symposium on Intelligent Information Technology and Security Informatics (IITSI), 2010.

[2] Reungsinkonkarn, Arun. "Hierarchical similarity

measurement model of program execution." in proceedings of the Software Engineering and Service Science (ICSESS), 2013 4th IEEE International Conference on IEEE, 2013.

[3] Salami, Hamza Onoruoiza, and Moataz A. Ahmed. "UML artifacts reuse: state of the art." arXiv preprint arXiv:1402.0157 (2014).

[4] Fenton, Norman, and James Bieman. Software metrics: a rigorous and practical approach. CRC Press, 2014.

[5] Idri, Ali, and Alain Abran. "A fuzzy logic based set of measures for software project similarity: validation and possible improvements." Software Metrics Symposium, 2001. METRICS 2001. Proceedings. Seventh International. IEEE, 2001.

[6] Idri, Ali, and Alain Abran. "Evaluating software project similarity by using linguistic quantifier guided aggregations." IFSA World Congress and 20th NAFIPS International Conference, 2001. Joint 9th. Vol. 1. IEEE, 2001.

[7] Azzeh, Mohammad, Daniel Neagu, and Peter Cowling. "Software project similarity measurement based on fuzzy C-means." Making Globally Distributed Software Development a Success Story. Springer Berlin Heidelberg, 2008. 123-134.

[8] Shepperd, Martin, and Chris Schofield. "Estimating software project effort using analogies." Software Engineering, IEEE Transactions on 23.11 (1997): 736-743.

[9] Tibermacine, Okba, Chouki Tibermacine, and Foudil Cherif. "A practical approach to the measurement of similarity between WSDL-based web services." Revue des Nouvelles Technologies de l'Information (2014): 03-18.

[10] Nahar, Nadia, and Kazi Sakib. "SSTF: A novel automated test generation framework using software semantics and syntax." Computer and Information Technology (ICCIT), 2014 17th International Conference on. IEEE, 2014.

[11] Nahar, Nadia, and Kazi Sakib. "Automatic Recommendation of Software Design Patterns Using Anti-patterns in the Design Phase: A Case Study on Abstract Factory." 3rd International Workshop on Quantitative Approaches to Software Quality.

[12] Yamamoto, Tetsuo, et al. "Measuring similarity of large software systems based on source code correspondence." Product Focused Software Process Improvement. Springer Berlin Heidelberg, 2005. 530-544.

[13] Imran, Asif, Alim Ul Gias, and Kazi Sakib. "An empirical investigation of cost-resource optimization for running real-life applications in open source cloud." Proceedings of High Performance Computing and Simulation (HPCS), 2012 International Conference on. IEEE, 2012.

[14] Kelter, Udo, Jrgen Wehren, and Jrg Niere. "A Generic Difference Algorithm for UML Models." Software Engineering 64.105-116 (2005): 4-9.

[15] Szlenk, Marcin. "Formal semantics and reasoning about uml class diagram." Dependability of Computer Systems, 2006. DepCos-RELCOMEX'06. International Conference on. IEEE, 2006

[16] Chen, Peter. "Entity-relationship modeling: historical events, future trends, and lessons learned." Software pioneers. Springer Berlin Heidelberg, 2002. 296-310.

[17] Firley, Thomas, et al. "Timed sequence diagrams and tool-based analysis case study." UML99 The Unified Modeling Language. Springer Berlin Heidelberg, 1999. 645-660.

[18] Klein, Cornel, Christian Prehofer, and Bernhard Rumpe. "Feature Specification and Refinement with State Transition Diagrams." FIW. 1997.

[19] Dong, Jing, Dushyant S. Lad, and Yajing Zhao. "DP-Miner: Design pattern discovery using matrix." Engineering of Computer-Based Systems, 2007. ECBS'07. 14th Annual IEEE International Conference and Workshops on the. IEEE, 2007.

[20] Smith, S., and D. R. Plante. "Dynamically recommending design patterns." SEKE. 2012.

Development of Real-Time 2.5 Dimensional Topographical Map for AR System of Excavators

^[1] Joo Hwan Park, ^[2] Do Hyung Shin (Corresponding Author)
^{[1][2]} Department of Civil Engineering, Inha University

Abstract:-- The purpose of the present study is to develop a real-time 2.5-dimensional topographical map based on the AR-Navigator system being developed by the authors, so as to provide the visual information required by excavator operators. The development of a real-time 2.5-dimensional topographical map is expected to lay the foundations toward automated construction equipment capable of autonomous operation.

Index Terms— Earthwork, Excavator, 2.5Dimensional Map, Construction, Automation

I. INTRODUCTION

Numerous efforts are being made from various approaches in the construction industry to enhance efficiency, and in the case of construction equipment, visual information maps have been studied as a means of providing useful information to operators to increase efficiency [1]. Based on this study, the authors are currently developing an AR-Navigator that Augmented Reality (AR)-based guide system for excavators. For the realization of the AR-Navigator system, a 2.5D topographical map that updates variations in ground elevation with excavation progression is necessary. Therefore the purpose of the present study is to develop the real-time 2.5D topographical map update system required by AR-Navigator. The following description of the technology at hand assumes an excavator with a bucket width of 1m.

II. AR – NAVIGATOR

AR-Navigator is a system that provides visual information to excavator operators through a tablet PC so as to improve the efficiency of work. One of the key features of AR-Navigator, shown in Fig. 1, is the showing of the current ground elevation with green color and as-designed ground elevation with purple color for the end of the bucket with visual AR image, so as to facilitate excavation. To this end, a 2.5D topographical map that updates the current ground elevation for the area being excavated is necessary.

The real-time 2.5D topographical map update system developed for this purpose is a key system comprising AR-navigator, and expresses topographical changes in earthwork sites in real-time, conveying changes in the ground level of the work area to the excavator operator. This is a key feature of AR-Navigator. As for data necessary for

use of the real-time 2.5D topographical map update system, these are the as-designed ground level, coordinates of the edge of the bucket, and an initial topographical map produced through a topographical scan. The initial topographical map is produced in point cloud data form by scanning, and is expressed in a data form suitable for the present system through the refining process shown in III.A of the present study. The as-designed ground elevation is obtained from the engineering drawings, while the position of the edge of the bucket is determined using GPS and an inclinometer [2].

III. ACKNOWLEDGMENT

This research was supported by a grant(17SCIP-B079689-04) from Construction Technology Research Program funded by Ministry of Land, Infrastructure and Transport of Korean government.



Figure 1. Edge of bucket, as-designed ground elevation, and current ground elevation shown on AR-Navigator

III. REAL-TIME 2.5D TOPOGRAPHICAL MAP

The real-time 2.5D topographical map requires an as-scanned topographical map that shows the ground elevation prior to excavation and which is obtained using a laser scanner, an as-designed topographical map, and real-time excavator bucket coordinates (XB, YB, ZB).

A. 2.5D topographical map generation

To generate the initial ground levels for the real-time 2.5D topographical map system, point cloud type as-scanned data from a laser scanner is used. However, use of a point cloud type topographical map in the present system without refinement poses the risk of slowing topographical map updates due to the excessive computation load caused by hundreds of millions of point data. To resolve this potential issue, the point cloud type topographical map needs to be transformed into mesh data by assigning Z coordinates using a grid comprising X and Y planes, reducing system load.

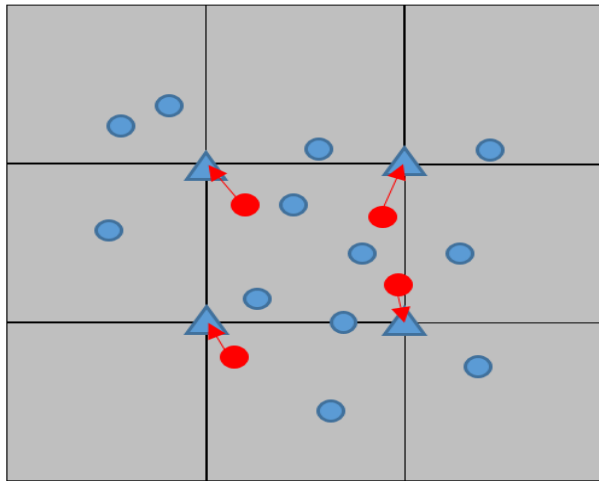

Figure 2. Dense Point Cloud Assignment

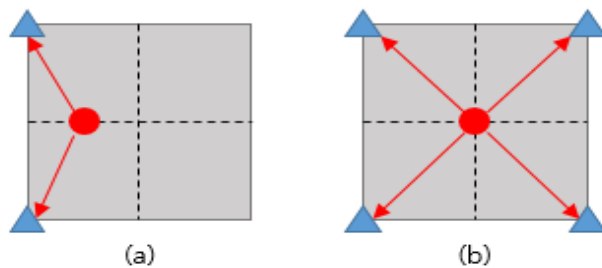

Figure 3 Sparse Point Cloud Assignment

That is, this process can be said to be a process where, due to storage capacity limitations, a high-resolution image is converted into a low-resolution image. The intersections on the grid used to convert point cloud type data to mesh data are referred to as grid points, and the point cloud points are assigned to these grid points. The X and Y coordinates

indicate the modified position of the excavator due to turning or movement.

However, simple conversion of point cloud data topographical map data into mesh data to reduce system load may cause a loss in accuracy. The intervals of the grid can be likened to the resolution of an image, as explained in the foregoing, this resolution for grid must be able to guarantee a certain degree of accuracy for the present system. Here, the resolution for X and Y in grid is 0.2m, this resolution having been decided through a trade-off between accuracy and the specifications of the system used for AR-Navigator..

Assigning of mass point cloud data to mesh data involves the entering of Z coordinate values into a grid expressed using only X and Y axes. Here, there are two methods of entering point cloud Z coordinate values into a grid point, depending on whether the point cloud is dense or sparse. In dense areas, when the point cloud is placed to overlap the grid is set as the grid point value, the ZP value which is the point cloud data closest to a grid point is assigned to each grid point as ZG, as shown in Fig. 2. The points indicated using circles show the point cloud coordinates (Pp, YP, ZP), while the intersecting points of the squares, including the triangles, indicate the grid point coordinate values (XG, YG, ZG).

As for areas where the point cloud is sparse, an insufficient number of points causes the situation shown in Fig. 3. If, as in Cases (a) and (b), a point equidistant from two or more adjacent grid points, indicated with triangles, to be assigned the same value. In this manner, a point cloud data type topographical map may be converted into mesh data and used for real-time topographical map updates.

However, prior to converting the point cloud data into mesh data, there may be noise caused during the scanning process by trees, workers, and construction equipment, etc. on the earthwork site, as shown in Fig. 4.

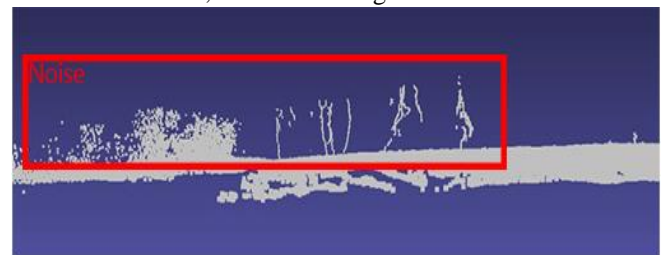

Figure 4. Noise in Scanned Point Cloud

As can be seen in Fig. 4, noise appears at a certain vertical distance from the ground. Unless the earthwork with explosions, the ground excavated is for the most part comprised of sandy soil and clay soil. Sandy soil, where the particles are weakly bound together, is expressed in the point cloud as a group of consecutive points with little

variation among adjacent points, and it is judged that there can be no substantial variation in Z coordinates between adjacent points at any given location. As for clay soil, whereas the particles are more strongly bound than in sandy soil, it is judged that high variation among a group of consecutive points on the point cloud is very low in validity. Accordingly, given a group of consecutive points, it is assumed that large variations of 0.5m or greater are outliers caused by construction equipment or workers. To remove such outliers, the Zp value of a point cloud data point other than the outlier is assigned to the corresponding grid point. It is judged that such method substantially reduces system load and contributes to enhancing computation speed. The generated 2.5D topographical map is expressed to the excavator operator on a plane comprising X and Y axes, with the Z axis values expressed using color variations.

B. Updating the topographical map

Using the mesh data type topographical map made by assigning point clouds to a grid, the changes in topography caused by earthwork are updated in real-time. Here, an update involves the updating of a ZG coordinate corresponding to X and Y coordinates on the grid to the ZB coordinate representing a point that the edge of the excavator bucket passes by. The positions where the coordinates (X, Y) need to be updated during excavation are found based on the movement of the edge of the bucket, as shown in Fig. 5. Also, the shape of the bucket, shown in Fig. 6 with a bucket tooth width of 0.1m, was given consideration. Therefore the movement of the bucket edge was expressed using a bucket edge area, which is defined as the bucket width (1m) times the bucket tooth width (0.1m). At a given point in time, the Z-B coordinates for all points within the bucket edge area are the same. In the case that, for a XP, YP coordinate set within the area, ZB is less than ZG, the ZG of the grid point is updated to ZB. As excavation work in general is carried out in linear fashion without turning, non-linear movement was not given consideration

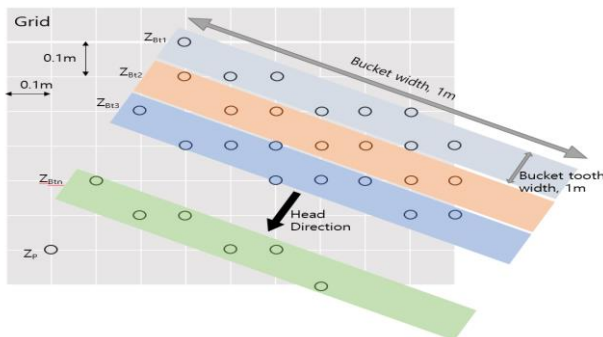

Figure 5. X, Y Coordinate Detection with Bucket Movement



Figure 6. Area of Bucket on Grid

The algorithm for the real-time topographical map update system, which is updated depending on the movement of the bucket edge during excavation, is as follows.

- 1) Receive the real-time position of the bucket from the GPS and inclinometer in the form of XB, YB, and ZB coordinates.
- 2) Find XG, YG on the path of movement of the bucket edge area during excavation.
- 3) To determine whether or not to update ZG, compare the ZG coordinate value for the XG, YG position against the ZB coordinate value.
- 4) If ZB is smaller, update ZG with the ZB value.

Real-time updating is defined as using the above-state algorithm, it is judged whether or not to update the ZG value of the grid point, and carrying out updating accordingly.

In AR-Navigator, the as-is ground elevation can be determined in real-time through such computations, and it is possible to compare the position of the bucket edge against the as-scanned topographical map to calculate differences in elevation.

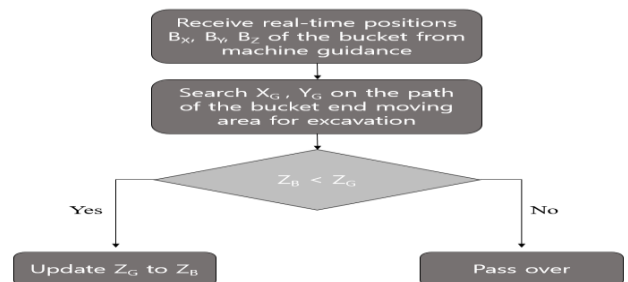

Figure 7. Algorithm for 2.5Dimensional Map Update

IV. CONCLUSION

In the present study, a real-time 2.5D topographical map required for AR-Navigator was developed. Tests as to the usability and accuracy of this real-time 2.5D topographical map update system in an actual construction site are being prepared, and points of improvement will be identified following such tests to further improve the present system. AR-Navigator with real-time 2.5D topographical map provides bucket edge, as-is ground elevation and as-designed ground elevation information in the form of an AR image, and is expected to improve excavator work efficiency. There is sufficient room for further improvement of the present system through future improvements to GPS system accuracy, and the present study is expected to contribute to the automation of construction equipment as well as the mechanical automated control of excavators.

REFERENCES

- [1] S. Song, H. Kang, H. Kim, T. Moon and D. Shin, "Task-Visual Information Map to Develop AR Navigators of Construction Equipment." Korean Journal of Construction Engineering and Management, Korea, vol. 17, no.3, pp. 116–124, May 2016.
- [2] Lee. K., Park. J., Kang. H. and D. Shin, "Seamless Superimposition Technique of Virtual Objects for AR System of Excavator Based on Image Processing" Korean Journal of Construction Engineering and Management, Korea, vol. 18, no.2, pp. 21–29, March 2017.

Military Spying Robot

^[1] Sarmad Hameed, ^[2] Muhammad Hamza Khan, ^[3] Naqi Jafri, ^[4] Adeel Azfar Khan, ^[5] Muhammad Bilal Taak
^{[1][2][3][4][5]} SZABIST Mechatronics dept.

Abstract: -- the possibility of the paper developed with a dream to see the spots we wish to see voluntarily in a military field. In this paper this thought is acknowledged at our fingertips. Robots are assuming a critical job in the military application. The vast majority of the work in the military is unsafe for person. In a war field or safeguard task a warrior needs to take his own specific manner to achieve the goal. The vast majority of the ways are perilous for a warrior. Consequently robot replaces the trooper. The paper is done to make a variant of spying robot that can empower us to watch the place of our advantage. The extent of the robot additionally helps it to be utilized as a covert agent robot. PIC 16F628A and PIC 16F877 are used for controlling all the processes. CCD camera is used to obtain real-time footages of the field. So in this way it will work in the way we acquire robot to work. To monitor the movement of the robot there is a transmitter which is attached on the robot. The explanation for manual control of the robot is that it won't be lost attributable to nonattendance of human inclusion. Notwithstanding long range applications it very well may be utilized as a government operative robot inside short distances.

Index Terms— CCD camera military, PICs, RF, spy robot, video transmission.

I. INTRODUCTION

The military is undeniably the primary customer of new advances and improvements in strategy, and is also often the sponsor of new improvements when it comes to envisioning new innovations in military settings. Numerous basic military technologies deployed out of the blue are now advanced to the piece of industrial robots. In any case, the importance of military autonomy and modern mechanical autonomy is still quite different. The military has special, robotic equipment while, in modern terms, the robot is a larger amount of a smart, adaptable, large-scale manufacturing machine. Later, the use of modern robots for military applications will always be imaginable. Cost and development of the specialized capacity of the innovative robot will build the enthusiasm of the military customers. In the research, we will demonstrate that the inspiration for the utilization of robots, inside the military and inside industry, is the substitution of people. The explanations behind this substitution are, as per the following: quality, cost and acculturation; be that as it may, utilizing an alternate methodology in each field, obviously [1].

Presently, the monitoring of International fringe zones is exceptionally overwhelming errand. The security forces observe the outskirts under antagonistic conditions. You get support from reconnaissance cameras officially assembled, but they cover exceptionally restricted zones. The cameras mounted viably at a settled position isn't of incredible use, as we can't change the camera look dynamic. Moreover, it is inconceivable to mount the cameras in the timberland regions as the trees discourage the camera's point of view [2].

The aim of structuring a robot is to encourage the individuals through giving security. The innovation utilized in this safeguard and security robot has various imperative

highlights, for example, mechanical vehicle control by RF technology and Wi-Fi, naturally maintaining a strategic distance from obstructions in its way. A high caliber remote camcorder outfitted the security forces observe the outskirts under antagonistic conditions. You get support from reconnaissance cameras officially assembled, but they cover exceptionally restricted zones. The cameras mounted effectively at a settled position isn't of extraordinary use, as we can't change the camera look dynamic. Moreover, it is inconceivable to mount the cameras in the timberland regions as the trees block the camera's point of view with a stepper engine for the omnidirectional view. This sound and video stream got from the recipient unit can be utilized to gain real ground, as shown by the got signs. This robot can likewise be utilized to achieve places where individuals can't achieve like concealed spots, little sections. A definitive focal point of this structure is to give the individual the most extreme security [3].

We are using RF technology for data communication between the robot and the user. Through CCD camera we are going to obtain maneuvers real-time videos of the place where the robot is moving. Here PIC microcontroller is the brain of the system, controlling all the tasks and actions performed by the robot.

II. LITERATURE REVIEW

The main idea to construct this robot is for the spying purposes, it for to keep an eye on people maneuvers in the battle ground or in the war days to reduce the chances of takeovers from the enemy side. Army people or entities have to face many dangers on their lives while spying on enemy or opposite entities. To overcome these ideas for this job robot will be more suitable and will decrease the risks of loss of human lives and can better spy illicit maneuvers of their opposite entities. Before entering to any doubtful districts we can send robot to check the status of that field

so the military or army individuals don't need to risk their life. These types of robot will be constructed in such a way that it would have a night vision camera mounted on it so in the darker places or in night it can record the view clearly. Camera will be controlled through remote by using an android application. Now a days there are many people who can construct an android application without any trouble. For communication we need to use some modules, if we use Bluetooth module it won't be much efficient for long ranges as the Bluetooth communication is weak not that strong. There are many different modules with their different specifications. For large ranges we can use Wi-Fi, Zigbee and many other can be used. Future scope of this robot is very vast, as it will continue to modify with time. For example it will be modified by planting gas sensors which will detect harmful gases in the surroundings. It can also be used as bomb diffuser in the future, bomb disposal team can have these robots which will help to diffuse bombs. The size of the robot can be scaled down to its minimal size [4].

The primary focal point of this exploration is the use of robots in wars and in harmony and their effect on the general public. This paper examines about advances utilized for spying and observation in various situations and condition. The creators examine the need and motivation behind building up the cutting edge robots for various, unforgiving and unpredicted condition of the war zones. They intend to present progressed controlling, self-ruling and rapid robots to serve for harmony in countries, as effectively as human controlled machines. Alongside these variables, they center on growing innovative weapons and hardware to be utilized. This government operative robot is easy to use. It can undoubtedly move, catch pictures and transmit them remotely on the checking screen where the warriors can see the present circumstance of the war field. The powers can design their guards as indicated by the risks been appeared through the robot. This robot is utilized for short separation reconnaissance for the security of that locale. The structure comprises of a vehicle having a camera for checking with a RF innovation for remote activities. The transmitter send the directions to the recipient for controlling the development of robot. The collector gathers and disentangles the gotten flags previously intensify the micro-controller which drives the motors through drivers. Remote of the camera can send live sound and visual recording to a PC or a TV through a tuner card to the station of remote controller. Current military forces are using different kinds of robots for different applications going from mine distinguishing proof to spare exercises. In future, they will be used for perception and surveillance, coordination and support, correspondences establishment, forward-passed on antagonistic exercises and as strategic fakes to cover move by keeping an eye on resources [5].

The task is to build a mechanical vehicle which will be controlled through the android application which will be linked or connected to the remote of the camera for observation purposes. The camera which is attached on the robot it will continuously send or transmits the data by special feature of CCD camera which is night vision competencies. This robot have a very useful application in the battle ground or war fields in form of spying purposes as an agent. As in this research paper, existing system is discussed where global system for mobile (GSM) – built mobile robot and Dual tone multi frequency build robot (DTMF) was used, these robots have realistic drawbacks for example, more vitality or energy is acquired to the system, the robot and the controlling unit must be in viewable pathway, for various Mobile phones, the control unit must be reassembled so that thusly the movement of the system is subordinate to cell phone. To end this requisite with a final goal, this research paper presents a voice over android application via Bluetooth connection. In this exam control on both remote correspondence between the versatile robots Android GUI application has been achieved. This framework can also be created by upgrading the execution and adding highlights. The improvement of this framework depends on the application used there. The frame may include highlights such as gas sensor, thermal image recognition, automated arm connection, and may be used in pick-and-place and so on should be possible. The improvement of this framework has been achieved by wide application zones, for example in army and legal authorization and industrialized and mischance organization criteria correspondence between the versatile robot Android GUI applications has been achieved [6].

This innovative robot system is constructed to perform various special tasks which is dangerous for human's life, which have his risk factor of human loss. On the whole we can say it can be used to perform task in cases where some crime happened and can be very important for military or army for keeping an eye on opposite entities or we can say purpose of spying. Some of the time it is important for a human which is bomb transfer master to incapacitate the gadget. For this reason, the master who uncovered the bomb will put on a defensive suit and protective cap, get a tool compartment of gear, and walk the 100 or so meters to the site. To achieve the bomb's area, it might be important to climb stairs, creep through entry way or even rests to satisfy the mission. This framework spares the profitable existence of our officers. This robot can also be used as robotic arms and mobile robots to go into armed force territory. The entire framework is controlled through android application. In this paper, usage of IOT information arranges in military condition has been demonstrated utilizing Wi-Fi framework accessible on mechanical vehicle and android telephones. The robot which have automated arm and autonomously movable robot have numerous applications in this field. If

the robot have these applications it will just not enter the danger zone and record but it can also move obstacles from its way and place things in front of itself to hide. Every step and performance will be tracked or can say recorded which will later analyze on big screen tenuously. This robot will also have a night vision camera which will allow the robot to see in darker places or in night time. This whole system would be fully controlled by android applications which will be easily accessible to the user. The Wi-Fi gadget and microcontroller which will get directions sends by the android application. The innovation can be enhanced further by offering directions to accepting circuit and control it by utilizing satellites correspondence. It will utilized in shopping centers for pickup, drop trolleys and car vehicle painting [7].

III. WORKING

There are some spying robots which are controlled by remotes, spying robot also have a camera in it and it also transmits video material or information to the mediation group or spying group. The size of these types of robots are usually suitably small so can travel more efficiently. The task that we have to perform, we have moveable military mediator or spying robot which will be controlled by remote, we have used PIC 16F628A and PIC 16F877. These type of robots which should be handle in a secret manner it have camera which will also controlled by remote, batteries, an antenna. We have used two different PIC's to control the robot and whole system through remote. In our robot we have also used CCD camera (charged couple device), it is used to latch all information or data to the robot. On our remote controlled 4 bit LCD is attached on top of it, to watch the direction of user. If the robot have to travel in dark areas or in night we have set up a LED light on the CCD camera with all the lightning circuitry. RF module (Radio frequency modules) are also used in this robot for receiving and transmitting the signals from remote to agent robot, so the user can control the robots speed, turning of robot basically whole control over the robot. To have good control over speed and turning we have used brushed DC motors (three) with its motor driver L2989 (two) in our military agent robot [8].

A. Microcontroller

As in figure 1, all the pin are defined with its use, as you can see in figure , 1,2,3,18,17 and 13 pins of PORT A are used to show output on remote which will be shown on LCD which is attached on the remote. These pins also have its control bits which are RA0, RA1, RA2, RA3, RA4 and RA7. Now we will come to port B, Port B have user input pins which are 0, 1, 2, 3, 4, 5 and 6, and the control bits of these pins are B6, B7, B9, B10, B11 and B12. These bits are used to control direction of motors and direction of camera. Bit B7 and B13 are information transfer carrying pins. At

pin 14 power source is connected +5V DC. Pin 5 is the ground pin.

Now look at figure 2, L2989 motor driver is controlled by the pins of PORT B, from B0 to B7 through this PIC. Pins of these bits are 33, 34, 35, 36, 37 and 38. There are two ground pins 12 and 31. Power source on pun 11 and 30 +5V DC.

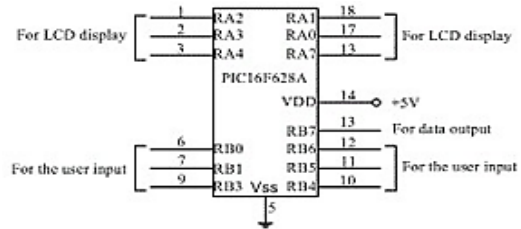

Figure 1 PIC16F628A

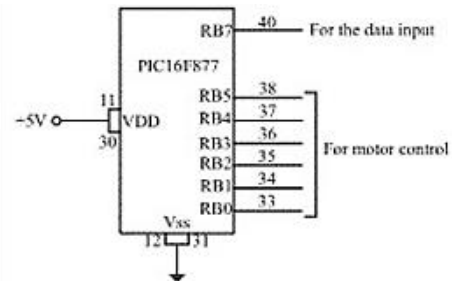

Figure 2 PIC16F877

B.L298N Motor Driver

This motor driver that we have used is linked with PIC 16877 to get control on robot. From figure we can analyze that B5 AND B4 bits are connected to the motor driver's pins. Pin 5 and pin 7, Pin 5 is input pin and pin 7 is info pin. Pin2 and pin 3 are also used and it is linked with brush DC motors. This motor driver is also connected with PIC16F877 to improve accuracy of the robot. B3 and B7 bits are linked to motor drivers pin5 and pin 7 for receiving data and pin 2 and pin 3 are used for transmitting data information to the motors of the left wheel. B1 and B0 bits are connected to the motor drivers pin 10 and pin 12 for receiving data and pin 13 and pin 14 for transmitting data to the motor of right wheel. Power source of +12V is given to driver and the fact is we have used brushed DC motors of 12V in this system.

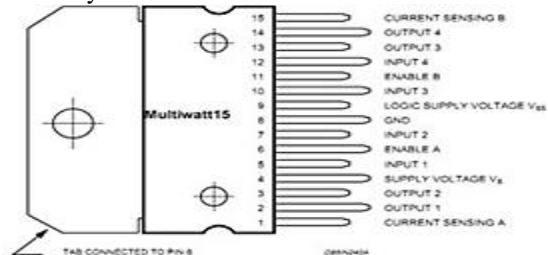

Figure 3 L2N98 MOTOR DRIVER

C. CCD Camera

CCD camera, full form Charged Couple Devices camera. This camera have various applications in all modified picture capturing devices. The remote that control this camera have a feature of sound and video system. The range of CCD camera is clear up to 100ft and the picture resolution is about 1024x800. CCD acquires power of +12V through lead batteries. This camera also can change directions (left and right) to get full view. Drawback of this camera have is that it have no USB port. It needs card which is shown in figure 4.



Figure 4 wireless CCD camera

D. Remote control:

The remote controller comprise of six press buttons and LCD which are utilized for administrator's info headings. There is an antenna which is use to receive and transmit the signals. Remote needs at +9v power to control whole system. Remote control circuitry have PIC 16F628A in it, also Radio frequency module is implanted inside the remote for communication with the robot. LM7805 voltage regulator is use to control the PIC 16F628A microcontroller. This voltage regulator is very suitable to control the steady potential voltage, it is also connected to the battery. Remote controller sends signals to the PIC 16F628A and radio frequency module individually. Basically the working is, the micro-controller that we have used will record the clients commands and transmits to the RF transmitter then, RF transmitter directs the data or information to the spying robot which will received by RF receiver. As you can see in figure 5, whole circuitry of remote controller is shown.

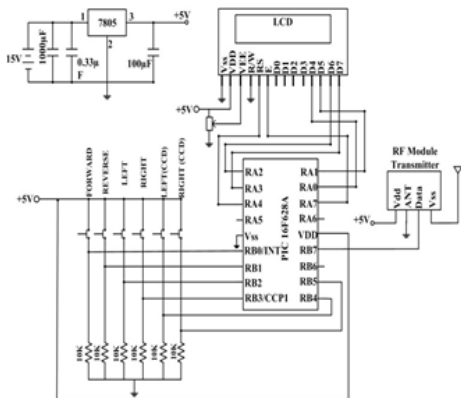

Figure 5 remote controller circuit

E. Robot Vehicle

This whole military spying robot consists of a CCD camera, we have four wheels, and three brushed DC motors, two L2989, RF module, two LM7805 and a micro-controller. The 16F877 micro-controller which is PLC that we have, we have forty pins to operate the robot. One LM7805 is used only for this PIC 16F877 to give the steady +5v to the micro-controller. The use of PIC 16F877 is not just of communication between system and RF module but also gives command to the motor driver to move robot in a very precisely way on the function path or route. Accuracy is very important in these robots. In our robot it consist of three DC brushed motors with its power source. To run these motors we need motor drivers and we have used L2989 motor driver. We r the have used two L2989 one for the brushed DC motors and one for the CCD camera. In our robot as we have mentioned we have used brushed DC motors each motor is connected to the wheel. Each wheel can move in forward and reverse direction due to brush DC motors reverse capability. One set of a DC motor is connected to control the movement of a project. And other set is mounted on camera for camera movement. At the camera pivot where it moves to control its movement two limit switches are also connected on both the directions left and right. When the camera interacts with the limit switch it will stop moving, camera won't work U-turn proficiency when it contacts with the limit switch.

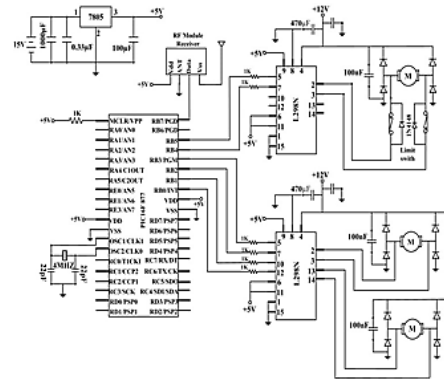

Figure 6 robot vehicle circuit

IV. METHODOLOGY

As shown in figure 7, the system works in this way that firstly, the commands are given to the receiver via the remote which is than processed and transmitted to the driver circuits which moves the motors. Than the commands are passed to the camera's motor and the rare wheel's motors which then moves accordingly. The footages obtained through the CCD camera are real-time transmitted to capture card of the camera and then is displayed on the screen.

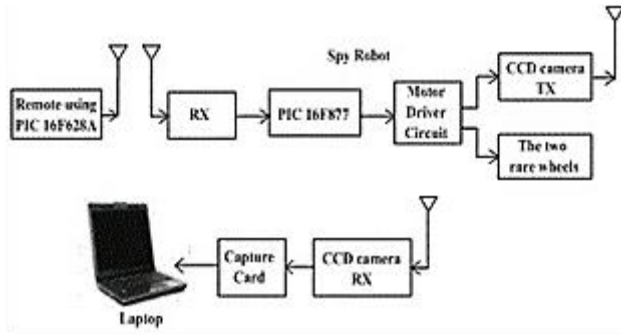

Figure 7 Spy Robot overview

Fundamental special coding is use in the modified PIC micro-controller. PLC’s pins of Port A and PORT B are used as input and output pins. PORT A pins of PLC 6F628 are simply connected with the LCD which is attached on the remote controller. Pins of PORT B of PLC 6F877 are connected to the L2980 motor driver. The RB 7 is used for serial communication input and output pins and having a baud rate of 9600. This program also have the ability to execute the transmitting and receiving commands.

V. RESULT

Amid tests, our plan works successfully. The essential metric for our paper would be precision. This has been tried to the best of our capacity. We have the ability to see exactly the things that are going on. As far as we can tell, our structure has created no disturbing influences. Depending on the course of the engine, the robot moves depending on the information we provide via the remote control. With the help of the camera, we can see the things going on in the region where the robot is hidden. By keeping the circuit direct, most customers have the capacity to use it effectively [10].

The goal of this paper is to limit human setbacks in psychological militant assault, for example, 9/11. The battle robot has been intended to handle such a brutal dread assaults. This robot is RF based, remote-controlled, and has every one of the controls like an ordinary vehicle. A remote camera was introduced to you, with the aim that it will screen opponents remotely, if required. It can quietly go into enemy zone and send us all the data through its small camera eyes. This undercover agent robot can show in star apartments, shopping malls, jewelry rooms, and so on, where there is risk of gatecrashers or scared mongers. Since human life is in every case valuable, these robots are the substitution of contenders against fear based oppressor in war zones [9].

VI. DIRECTION FOR FUTURE RESEARCH

This spying robot can be modified and made it for prolonged ranged and can be make it more useful by

consuming more operational procedures and modules like Wi-Fi module, raspberry pi. Future scope of this robot is very efficient it may have gas sensors to detect the harmful or hazardous gases in the surroundings. It can also be used as bomb diffuser and bomb disposal team can also use these type of robot in many ways and reduces the risk factor of human loss. Further, a terminating framework can be set on the robot, to fire any foe when he is spotted. The innovation can be enhanced further by offering directions to accepting circuit and control it by utilizing satellites correspondence. It will utilized in shopping centers for pickup, drop trolleys and car vehicle painting. Likewise, the framework can be made android based, where all controlling should be possible through an advanced mobile phone. There is a light called halogen light which is useful for the camera’s vision which is attached on the robot. This robot can also be controllable by giving commands through voice it will response to the voice commands also.

VII. CONCLUSION

The essential point of view of the military reconnaissance robot should make it straightforward. The administration operator robot can move without quite a bit of a track, getting pictures and transmitting them remotely, at that point the warriors give a recommendation about the dangers and conditions in the field of war. The robot moves relying upon the engines, which are reliant on the data we give about the transmitter (remote). RF signals are utilized as control signals. By utilizing these characters, the coding is done and signal is sent by the sender. At the beneficiary end, this decoded banner is given as a commitment to the drive of the engines. The robot is utilized for brief detachment and along these lines ensures the wellbeing of the territory. This makes the powers see precisely what's going on in the encompassing locale and to set it up as it ought to [5]. With the assistance of this proposed advancement, there is some help for our security controls in area of interloper. This mechanized structure can likewise be utilized in high height territories where it is troublesome for people, as a feature of our edges fall into high elevation areas. The proposed computerized structure can likewise be utilized in the look for the harmed individuals amidst disasters, for example, trembling, falling of the building and past in the mining zones [2].

REFERENCES

- [1] Military robots of the present and the future, AARMS TECHNOLOGY Vol. 9, No. 1 (2010) 125–137
- [2] design and implementation of e-surveillance robot for video monitoring and living body detection, Dr. Shantanu K. Dixit*, Mr. S. B. Dhayagonde, International Journal of Scientific and Research

- Publications, Volume 4, Issue 4, April 2014 ,ISSN 2250-3153
- [3] Distance Controlled Rescue and Security Mobile Robot, Golap Kanti Dey, Raqibul Hossen, Md.Shafayet Noor, Kazi Tanvir Ahmmmed, IEEE 2013
 - [4] Arduino Controlled War Field Spy Robot using Night Vision Wireless Camera and Android Application, Jignesh Patoliya, Haard Mehta, Hitesh Patel, 2015 5th Nirma University International Conference on Engineering (NUiCONE)
 - [5] War Field Spying Robot Using Wireless Camera, Kunj Gudhka, Aishwarya Kadam, Devika Kale, Manil Rupani, Prof. Tilottama Dhake, International Journal of Electrical and Electronics Research ISSN 2348-6988 (online) Vol. 4, Issue 1, pp: (85-92), Month: January - March 2016
 - [6] SMART PHONE BASED ROBOTIC CONTROL FOR SURVEILLANCE APPLICATIONS, M.Selvam, IJRET: International Journal of Research in Engineering and Technology, Volume: 03 Issue: 03 | Mar-2014
 - [7] Military Spying and Bomb Disposal Robot Using IOT, 1CHAITRALI JADHAV, 2SHAMLI GIBILE, 3SNEHAL GAIKWAD, 4NEELUM DAVE, International Research Journal of Engineering and Technology (IRJET) e-ISSN: 2395-005 Volume: 05 Issue: 04 | Apr-2018
 - [8] DESIGN AND IMPLEMENTATION OF REMOTE OPERATED SPY ROBOT CONTROL SYSTEM, International Journal of Science, Engineering and Technology Research (IJSETR), Volume 3, Issue 7, July 2014
 - [9] Design of an Intelligent Combat Robot for war, Dr.S.Bhargavi, S.Manjunath, (IJACSA) International Journal of Advanced Computer Science and Applications, Vol. 2, No. 8, 2011
 - [10] Robot Assisted Emergency Search and Rescue System With a Wireless Sensor Network, International Journal of Advanced Science and Technology Vol. 3, February, 2009

Design, Fabrication and Experimentation of Swing Electricity Power Generation System

^[1] Juntakan Taweekun, ^[2] Saba arif, ^[3] Mas Fawzi, ^[4] Nor Zelawati Binti Asmuin,
^[5] Mohd Faizal Mohideen Batcha, ^[6] Zamri Noranai

^[1] Department of Mechanical Engineering, Faculty of Engineering, Prince of Songkla University, HatYai, Songkhla 90112, THAILAND, ^[2] Department of Mechanical Engineering, Institute of aerospace and avionics, Air University, Islamabad, Pakistan, ^[2] Energy Technology Program, Faculty of Engineering, Prince of Songkla University, HatYai, Songkhla 90112, THAILAND, ^{[3][4][5][6]} Centre for Energy and Industrial Environment Studies (CEIES), Universiti Tun Hussein Onn Malaysia, 86400 Parit Raja, Batu Pahat, Johor, MALAYSIA.

Abstract:-- Energy need of today's world is growing day by day because of consumption of larger extent of electricity due to growing population. Project is about generation of electricity by swing. Large number of children play in a playground, part of the power of their play caused by swing can be usefully harnessed resulting in significant energy storage. Yielded energy can be converted to electrical energy to be utilized for many applications. Oscillatory motion of swing is transferred to shaft attached, which further transfers its angular motion to rotary motion of the flywheel, rigidly connected at the end. The flywheel is connected to a generator by specific transmission to conserve and increase the speed at generator end. The generator converts the mechanical energy into electrical energy to be utilized for many applications. Current swing is able to generate enough electricity to power a 15 W DC fan and a 9 W DC bulb. The method provides a low-cost, low-resource means of electricity generation, especially for use in developing countries.

Keywords: Electricity generation, Swing, Battery, Alternative energy, Cheap and low resource.

I. INTRODUCTION

The major concern of the today's world is energy crisis [1-5]. The natural resources are limited which are used to power industrial society because of rising demand day by day. Energy crisis is due to the limited utilization of renewable and alternate energy sources[6-7]. The coal fired plants are extensively used across the globe to about 41% for electricity generation but leads to severe environmental problems[8-9]. So, by setting our energy trend towards the use of renewable and alternate energy sources, we can overcome the energy crisis as well as environmental pollution in an efficient way[10].

There is a lot of availability of mechanical energy in the environment which can be converted to other forms like electrical energy[11]. Like in a playground, the swings can be efficiently harnessed producing significant energy storage. Hence, an optimal designing of Swing electricity generation system has huge energy saving potential[12-14].

The main objective of the project is to convert the mechanical energy caused by the swinging action of the

swing to electrical energy with the help of different mechanical linkages i.e. sprockets and flywheel.

To get the energy output from this type of system in which energy is going to be wasted for in vain is a big achievement.

II. WORKING PRINCIPLE

The motion of swing in the forward and backward direction causes the shaft to rotate at an angle. The shaft is supported by the bearings at both ends. The sprocket is attached at one side of the shaft which rotates when the shaft turn through an angle. The compound system used is shown in the fig 1. The sprocket sets transmits the power to the flywheel using the compound system shown. The flywheel conserves and increases the speed of the attached shaft. Another chain and sprocket set is used to convert the motion of flywheel to the generator shaft. The generator shaft rotates and produces electricity which can be stored in the battery which in turn can be used for numerous useful applications.

2.1. ADDITIONAL FEATURE

The system comprises of the two ratchets attached on the flywheel shaft. The both ratchets are attached at the same axis with the opposite rotating axis as seen in the Figure 1. On the forward motion of the swing first ratchet works and transmits power to the flywheel and the second ratchets moves free. On the contrary, the second ratchet works and first moves free. So the flywheel gets the torque on the both directions i.e. forward and backward. By this principal, more rpm is maintained at the generator end yielding the electricity generation at a larger rate because flywheel is getting torque for both directions instead of one used commonly.



Fig 1: Compound System of Swing

III. MATERIALS AND METHODS

Current project started from problem statement followed by the literature review, solid modeling, mathematical modeling, design, fabrication and ended at the experimentation. The purpose is to divert the attention of people towards the alternative energy which is pollution free and low resource mean of electricity production. In this way the energy crisis can be controlled.

IV. RESULTS AND DISCUSSIONS

Calculations were made to find the number of oscillations that will fully charge a 12 V, 7AH battery. The ideal charging time comes out to be as:

The ideal charging time = $\frac{7AH}{1.5 A} = 4 \text{ hours } 40 \text{ minutes}$
 Where 1.5 A is the average output.

There are 25% losses in a battery. So by considering losses the actual charging time comes out to be 5 hours 50 minutes.

The battery run time is calculated as follows:

The loads we used were:

- 15W DC fan
- 9W DC bulb

Using formula;

$P=VI$ Eq(01)

$(15 + 9)W / 12V = 2A$ Eq(02)

Discharging time = $\frac{7AH}{2A} = 3.5 \text{ hours} = 3 \text{ hours } 30 \text{ minutes}$

This means that the fan and the light together can last for about 3 hours and 30 minutes when the battery is fully charged. If both the loads are used separately then they can last longer. Table 01 shows all specification of the current system.

Table 1 SPECIFICATIONS OF THE SYSTEM

Generator Output	20 V, 1.5 A
Battery used	7AH, 12 V
Charging Time	4 hours 40 mints
Discharging Time with full load	3 hours 30 mints
DC fan	12 V, 15W
DC Bulb	12 V, 09W

V. EXPERIMENTATION

Experimentations were performed by getting the voltage output at a specific value of RPM. Table 02 shows obtained results.

Table 02 power output Vs Voltage analysis

RPM	Voltage(volts)
120	7.2
160	10.3
220	15.8
250	19.5
344	22

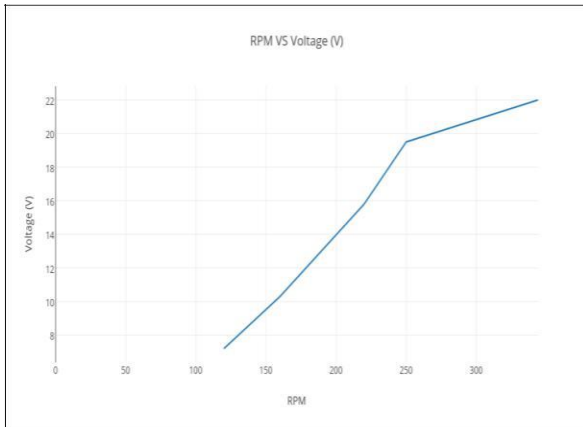

Fig 2: RPM VS Voltage

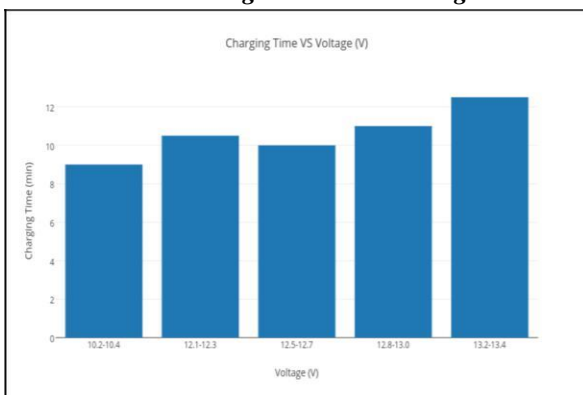

Fig 3: Charging Time Vs Voltage

VI. CONCLUSION

Electricity plays a major role in human life. In the world of today we need to discover new ways of generating power. And to save our natural reserves, Electricity generation from swing is one of such ways. We are successful to demonstrate the electricity can be generated through the idea we put forward. Current swing is able to generate enough electricity to power a 15 W DC fan and a 9 W DC bulb. We attach 12 V, 7AH battery with a charging circuit, which stores and regulates the pulsating current. The battery is fully charged in 4 hours and 40 minutes. The completely charged battery can power a 15 W DC fan and a 9 W DC bulb for approximately 3 hours and 30 minutes.

VII. ADVANTAGES AND APPLICATIONS

The following advantages can be obtained from the system:

- It is pollution free system.
- DC output can also be achieved.

- Maintenance is easy.
- The system has huge worth at the places like parks, schools and playgrounds where children use swing.
- Electricity can be stored in battery which can later be used in many applications.

The prototype can be installed in parks, schools, picnic points and homes. The electricity produced can be efficiently used to light the places described above.

VIII. REFERENCES

- [1] n. A. Unar, "energy crisis causes, Effect sandremedies,"In linkedin, 2016. Available: <https://www.linkedin.com/pulse/energy-crisis-causes-effects-remedies-naveed-ahmed-unar>. Accessed: oct. 17, 2016.
- [2] m. Anwar, "solutions for energy crisis in pakistan", in solutions for energy crisis in pakistan, islamabad, 2016, p. 8.
- [3] "effects of electricity crisis in pakistan", energy crisis, 2016.
- [4] "disadvantages of load shedding", pakistaneconomist.com,2016.Available:<http://www.pakistaneconomist.com/database2/cover/c2009-22.php>. [accessed: 19- oct- 2016].
- [5] d. Naseem and j. Khan, impact of energy crisis on economic growth of pakistan, 7th ed. International journal of african and asian studies, 2015, pp. 1-6.
- [6] a. Samad, f. Xiumei, and n. Sangi, "current power generation and Alternative trends in pakistan,"sci.int., vol. 28, no. 3, Pp. 2321–2325, may 2016. Available: <http://www.sci-int.com/>. Accessed: oct. 17, 2016
- [7] a. Nawaz khan, t. Begum and m. Sher, "energy crisis in pakistan: causes and consequences", abasyn journal of social sciences, vol. 4, no. 2, pp. 345-349, 2013.
- [8] s. R. Pandian, "a human power conversion system based on Children's play,"
- [9] s. Kawamura, t.yonezawa, k.fujimoto, y. Hayakawa, t. Isaka, and S.r.pandian, 2000, "development of an active orthosis for knee Motion by using pneumatic Actuators",international Conference on machine automation (icma 2000), osaka, japan, pp.615-620.

[10] r. Wairagade, s. Tagwan, and p. S. K. Mude, "electrical energy generation By using pendulum motion," international journal of advance research, ideas and Innovations In Technology, vol. 2, no. 2.

[11] S. Nithiya, K. Sadhuna, and A. Saravanan, "Energy Harvesting Using Oscillating Pendulum," International Journal for Research and Development in Engineering (IJRDE), pp. 017–019.

[12] M. Gajbhiye, M. Boke, A. Kelwadkar, and S. Mude, "Electrical Energy Harvesting By Using Pendulum Power Generator," International Research Journal of Engineering and Technology (IRJET), vol. 03, no. 02, pp. 595–599, Feb. 2016.

[13] V. Rukkumani, P. Balaji, R. Elumalai, M. Kavin, and A. Aravindh, "High Electricity Generation using Oscillations of Pendulum," Journal of Electronic Design Engineering, vol. 02, no. 02, 2016.

[14] M. CJ, S. P, and M. K, "swing electricity generation system," International Journal of Scientific Progress & Research, vol. 13, no. 01, pp. 54– 56, 2015.

Utilization Manufactured Sand as Fine Agregate for Concrete Quality

^[1]Ranti Hidayawanti, ^[2]Supriadi Legino, ^[3]Iriansyah Sangadji
^{[1],[2],[3]}Sekolah Tinggi Teknik PLN

Abstract: -- Utilization Manufactured sand (M-sand) in this case of ash sandstone wash as a substitute for sand on concrete mixture is used as a result of the crisis in availability of the main material of concrete, ie natural materials such as sand used in concrete manufacture foundries. M-sand from the production of crushed stone then collected and washed which will be used as a mixture of sand on the concrete. The results of m-sand optimally utilized for the mixture of fine agregate substitution of concrete with compressive strength test to produce high quality of concrete. The mixture used is 50% m-sand and FA, from the results of the compressive strength test showed the utilization of m-sand can be used as a quality concrete

Keywords — M-sand, fine agregate, waste, compressive strength, concrete quality.

INTRODUCTION

The development of construction in Indonesia occurred so fast, many studies have been done to develop construction technology ranging from construction materials to technology used in the construction itself, with manufactured sand is an effective approach to reduce the natural resource depletion and environmental impact of cement concrete industry[1]. Several utilization of waste can be used for optimalization of concrete construction materials because. the construction of high-rise buildings currently demands good quality materials, almost 70% of the use of materials from the building is concrete so that to meet the construction of high-rise buildings will be demanded high-quality concrete [2]. The development of these construction materials can be seen from the many types of added materials used as additives in the normal concrete mortar. These added compositons aim to improve the concrete to be better and reduce waste. The condition of material difficulties experienced by foundries in Indonesia started in 2009, where the sand of bangka as the main material of sand in Jakarta area is constrained by various causes, so the supply becomes less smoothly, besides consistency to quality not in accordance with the requirement. The non conformace for 1% mud will require the addition of 7 kg/m³ cement, for fine fine fine (smaller than spec) will impact more free water usage which means more cement use to achieve the same quality, in addition to the effect of bleeding then cracked concrete. M-sand is widely considered as an alternative of the river sand recently, and to clarify the influence significance and influence mechanism of MS characteristic parameters on its

concrete performance is essential to its scientific application[3]. Utilization of m-sand to reduce the use of sand. Global warming issues caused by environmental damage are the dominant factors causing the difficulty of obtaining sand material, government regulation to regulate sand mining, crushed stone, regional autonomy including things that make people involved in determining policy direction, making it harder to get sand material, so that the material is scarce, the more expensive and the more unusual the expected quality is required and all these things will affect the quality of concrete products, the cost of concrete composition that affects the price of competitiveness, and the smooth service to customers will be disrupted. As an effort to find a solution to overcome the mentioned above, it is necessary to conduct study on the possibility of using m-sand material with production capacity ± 1000 m³/day, with condition not fulfill the specification for concrete material, $\pm 19\%$ mud level, by washing to be used as a substitute material for sand needs in addition to attempting to reduce cost reduction programs to enhance competitiveness. Foundries successfully recycle and reuse the sand many times in a foundry[4]. The utilization of such materials in concrete not only makes it economical, but also helps in reducing disposal concerns[5]. The goal of this paper is to know the effect of m-sand against compressive strength and increase the use of m-sand up to 50%.

LITERATURE REVIEW

In recent years, manufactured sand (m-sand) produced by crushing stone deposits is being identified as a suitable alternative source for river sand in concrete[6]. Sand is the one of main constituents of concrete making which is about

35% of volume of concrete used in construction industry[7]. Review Concrete is the most widely used material in the construction of buildings and infrastructure development[8]. Fundamentally, concrete should be economical, strong, and durable. The construction industry recognizes that considerable improvements are essential in productivity, product performance, energy efficiency, and environmental performance[9].The development of foundries industry is a promising business in Indonesia as a developing country. Indonesia still badly needs concrete as the main material to carry out the construction of other types of structures, roads, bridges and other infrastructures. Reuse of waste materials as construction material is very much essential to achieve sustainable construction. Utilization of waste materials as construction material not only help in protection of environment but also result in monetary savings [10]. According to [11] the suitability of crushed stone ash waste as fine aggregate for concrete has been assessed by comparing its basic properties with that of conventional concrete. The strength characteristics of the concrete depend on the nature of the constituent material and its combined action. Fine aggregate is one of the important constituents as far as the strength characteristics of the concrete are concerne. Increasing demand and decreasing natural sources of fine aggregate for the production of concrete has resulted in the need to identify new sources of fine aggregates. The most commonly used river sand as a fine aggregate in the production of concrete and mortar raises the problem of acute shortage in many areas. At the same time increasing amount of crushed stone ash is available from crusher as waste. This ash removal is a serious environmental problem. If it is possible to use this crushed stone ash in the manufacture of concrete and mortar with partial or complete replacement of natural river sand, this will not only save the construction cost but at the same time will solve this ash removal problem.

MATERIAL EXPERIMENT

Material used

Table 1. Material Data to Mix Trial Bangka's Sand 50% + M-sand 50% + Fly Ash 20%

No.	Item	Name of Supplier	Weight	Water (%)	Absorption %	Used %	Max Size mm	PAS 30 %	FM	% finer than 0,075 mm
1	Cement	Gresik	3,15			0,8				
2	Fly Ash	Surabaya	2,14			0,2				
3	Sand 1	Bangka	261	5,1	0,76	50		47,80	2,57	
4	Sand 2	Wash stone Ash (RUMPIN)	259	9	2,38	50		33,00	3,14	2,05
5	Spli 1-2	ADHMMX	261	200	1,2	100	25		6,95	0,67
6	ADD	BASF-POZZOLITH 100R	1,02			0,3				

Experimental Steps

As for the sequence of experiments or experimental steps, are as follows :

1. Material testing in Laboratory.

2. Laboratory washing experiments.
3. Mortar compressive strength experiment comparative with Bangka Sand (river sand).
4. Trial Mix to look for correlation w/c to strength.
5. Evaluation of Trial Laboratory results.

Experiment Set Up

The washing system will be made using, the screw system utilizes the former waste wash project which fails, although it is necessary to experiment in advance to know the effectiveness of the tool on the quality of ash, and the capacity of the tool.



Fig.1 Tube Container Material



Fig.2 Material Washers

The first step of the experiment was carried out on a laboratory scale by washing the stone ash to obtain the quality of stone crushed in accordance with the requirements, ie stone ash with a mud content of less than 7%. Then the m-sand is used as a concrete mixture with a 50% percentage of the total sand requirement in 1 m³ of concrete.

RESULT AND DISCUSSION

From the results of laboratory tests produced data as follows :

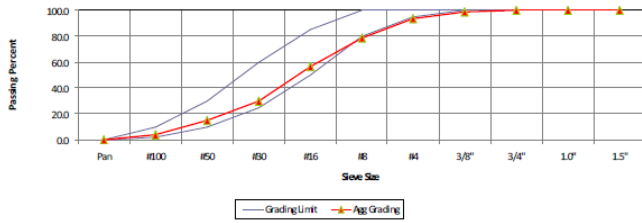

Fig. 3 Grading material of Bangka Sand / Belitung

By looking at the fineness of the bangka sand for a 50% sieve of 20%, for a 30% sieve of 40%, and a sieve of 40 is 100% and all still within usable limits.

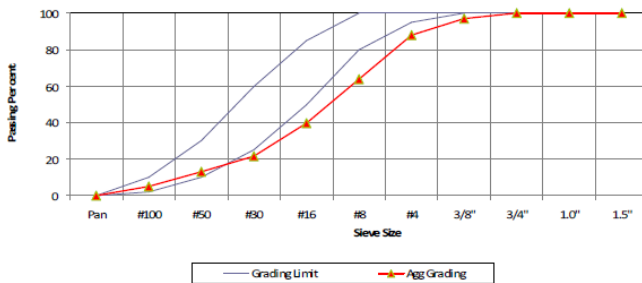

Fig. 4 Grading material of M-sand

From the picture above shows that a 3/4 sieve of 100% means m-sand is finer than bangka sand which means better mixing of concrete because the air cavity in concrete will be filled with ash so that the mixture is more solid than pure bangka sand. River sand was replaced by manufactured sand (M-sand) at replacement levels of 20,40,60,80 and 100% [12]

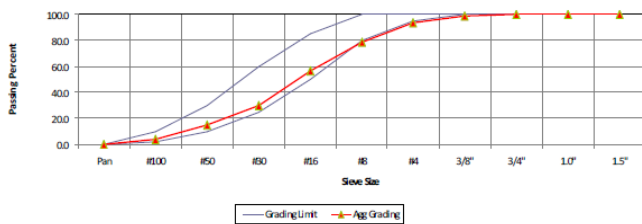

Fig. 5 Grading combined of Bangka sand and M-Sand

From the picture above looks 3/4 sieve of 100% means the mix between m-sand and sand of bangka still enter the gradation limit. if above the graph can not be used as well as under the lower limit.

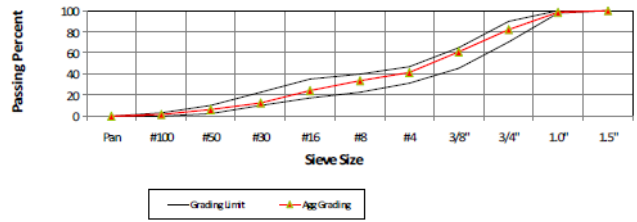

Fig. 6 Material combined max. 25mm

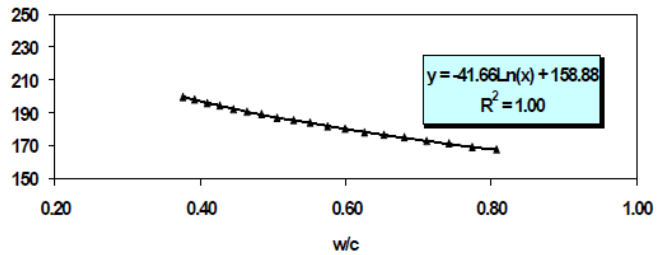

Fig. 7 Free water requirement per m³ to slump 12 cm

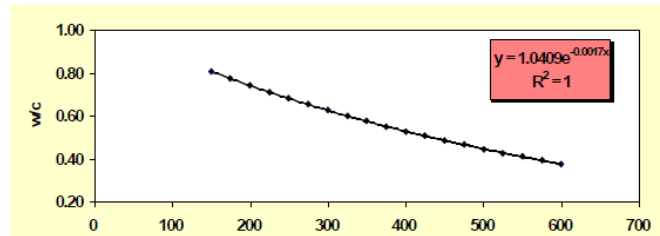

Fig. 8 Correlation w/c to compressive strength

Table 2. Mix Design Concrete of Bangka 50%, M-sand 50%, Split 100%, Fly Ash 20%

No.	Quality (K)	Shmp (cm)	Deviation	Goal	Fas	S/A (%)	Material Composition (SSD)						Admixture			Weight of Concrete			
							Cementations	Cement	Fly Ash	Stone Ash	Sand	Split 1:2.5	Split 2:3.5	Water	Type F		Type D	Type G	
			kg/cm ²	kg/cm ²			kg/m ³	kg/m ³	kg/m ³	kg/m ³	kg/m ³	kg/m ³	kg/m ³	kg/m ³	kg/m ³	kg/m ³	kg/m ³	kg/m ³	kg/m ³
1	100	12±2	30	149	0.808	52	208	166	42	511	511	952	0	168	0	0.62	0	2349	
2	125	12±2	30	174	0.774	51	219	175	44	499	499	959	0	170	0	0.66	0	2348	
3	150	12±2	30	199	0.742	50	231	185	46	488	488	966	0	171	0	0.69	0	2346	
4	175	12±2	30	224	0.711	50	243	195	49	478	478	972	0	173	0	0.73	0	2344	
5	200	12±2	30	249	0.681	49	257	205	51	467	467	976	0	175	0	0.77	0	2343	
6	225	12±2	30	274	0.653	48	270	216	54	457	457	980	0	177	0	0.81	0	2341	
7	250	12±2	30	299	0.626	48	285	228	57	447	447	982	0	178	0	0.86	0	2340	
8	275	12±2	30	324	0.600	47	300	240	60	437	437	984	0	180	0	0.90	0	2338	
9	300	12±2	30	349	0.575	47	316	253	63	427	427	984	0	182	0	0.95	0	2337	
10	325	12±2	30	374	0.551	46	333	267	67	417	417	985	0	184	0	1.00	0	2336	
11	350	12±2	30	399	0.528	46	351	281	70	408	408	981	0	185	0	1.05	0	2334	
12	375	12±2	30	424	0.506	45	370	296	74	398	398	978	0	187	0	1.11	0	2333	
13	400	12±2	30	449	0.485	45	390	312	78	389	389	974	0	189	0	1.17	0	2332	
14	425	12±2	30	474	0.465	44	410	328	82	380	380	969	0	191	0	1.23	0	2331	
15	450	12±2	30	499	0.446	44	432	346	86	371	371	965	0	193	0	1.30	0	2330	
16	475	12±2	30	524	0.427	43	455	364	91	362	362	966	0	194	0	1.37	0	2329	
17	500	12±2	30	549	0.409	43	479	383	96	353	353	967	0	196	0	1.44	0	2329	
18	525	12±2	30	574	0.392	42	505	404	101	345	345	968	0	198	0	1.51	0	2328	
19	550	12±2	30	599	0.376	42	531	425	106	334	334	977	0	200	0	1.59	0	2328	

From the concrete experiments, it was shown that 50% m-sand after washing (mud content meets the standard) with 50% Bangka Sand produce the same compressive strength as 100% Bangka Sand mix . So from the base of the experiment then made a plan to make a washing plant to

obtain or improve the quality of the M-sand which during this high mud content is $\pm 19\%$.

CONCLUSION

From the above experimental data, the following conclusions can be drawn as follows:

1. High mud content in the stone ash can be lowered by washing using clean water, so stone ash material quality meet qualifies.
2. The compressive strength using 50% m-sand combined with 50% bangka sand with mud content as required, produces the same compressive strength as 100% of master bangka.
3. The use of m-sand can lower the cost of materials, this is because the price of m-sand is cheaper than bangka sand.
4. M-sand can neutralize the organic content in the sand of Bangka is sometimes high.
5. The use of m-sand can improve the grading of material combinations, because the dispersion of stone ash grains is between the split grains and the sand of Bangka
6. For Bangka Sand with low fine agregate (smooth), Stone ash can neutralize the weakness, so obtained fine agregate and gradation of the ideal Sand

ACKNOWLEDGEMENT

The authors would like to thanks for Concrete Laboratory, and the leaders of STT PLN whom all have provided moral support, material aid, as well as parties that are really helpful, both directly and indirectly, in making this paper possible.

REFERENCES

- [1] W. Shen *et al.*, "Mixing design and microstructure of ultra high strength concrete with manufactured sand," *Constr. Build. Mater.*, vol. 143, pp. 312–321, 2017.
- [2] R. Hidayawanti, S. Legino, and D. Harjanto, "OPTIMIZING THE UTILIZATION CEMENT SLAG AND FLY ASH OF," no. March, pp. 14–18, 2018.
- [3] W. Shen *et al.*, "Influence of manufactured sand's characteristics on its concrete performance," *Constr. Build. Mater.*, vol. 172, pp. 574–583, 2018.
- [4] R. Siddique, G. de Schutter, and A. Noumowe, "Effect of used-foundry sand on the mechanical properties of concrete," *Constr. Build. Mater.*, vol. 23, no. 2, pp. 976–980, 2009.
- [5] R. Siddique and G. Singh, "Utilization of waste foundry sand (WFS) in concrete manufacturing," *Resour. Conserv. Recycl.*, vol. 55, no. 11, pp. 885–892, 2011.
- [6] P. Nanthagopalan and M. Santhanam, "Fresh and hardened properties of self-compacting concrete produced with manufactured sand," *Cem. Concr. Compos.*, vol. 33, no. 3, pp. 353–358, 2011.
- [7] R. N. U. Shanmugapriya T., "Optimization of Partial Replacement of M-Sand By Natural Sand in High Performance Concrete With Silica Fume," *Int. J. Eng. Sci. Emerg. Technol.*, vol. 2, no. July, pp. 73–80, 2012.
- [8] M. Padmanabhan and P. H. Paulose, "Behaviour of Concrete Made by Partially Replacing Fine Aggregate with Foundry Sand and Quarry Dust," pp. 3279–3282, 2018.
- [9] M. Popek and Ł. Sadowski, "Effect of selected mineral admixtures on mechanical properties of concrete," *Key Eng. Mater.*, vol. 728, 2017.
- [10] R. Siddique, G. Singh, and M. Singh, "Recycle option for metallurgical by-product (Spent Foundry Sand) in green concrete for sustainable construction," *J. Clean. Prod.*, vol. 172, pp. 1111–1120, 2018.
- [11] J. A. Mary, "An Experimental Investigation on Stone Dust as Partial Replacement of Fine Aggregate in Concrete," vol. 3, no. 5, pp. 229–232, 2014.
- [12] K. Praveen Kumar and Radhakrishna, "Characteristics of SCC with Fly Ash and Manufactured Sand," *IOP Conf. Ser. Mater. Sci. Eng.*, vol. 149, no. 1, p. 012111, Sep. 2016.

Data Management for Interdisciplinary Mechatronic Systems

^[1]Hani Balkhair, ^[2] Clarence de Silva
^[1] University of British Columbia, ^[2] University of British Columbia

Abstract: -- These instructions give you guidelines for preparing papers for the International conference (ICCSE). Use this document as a template if you are using Microsoft Office Word 6.0 or later. Otherwise, use this document as an instruction set. The electronic file of your paper will be formatted further at International Journal of Computer Theory and Engineering. Define all symbols used in the abstract. Do not cite references in the abstract. Do not delete the blank line immediately above the abstract; it sets the footnote at the bottom of this column.

Index Terms—About four key words or phrases in alphabetical order, separated by commas.

I. INTRODUCTION

Many mechatronic products data that are created throughout the design development process need to be managed. Product models are used for the support of product data management (PDM), in which all the information pertained are accessed, stored, served, and reused by stakeholder [1]. The huge volume of data involved in product models in different level of details throughout the design process poses a big challenge.

Computer-based tools used for the support of product data have always been developed for a specific discipline such as CAx, EES (Electrical/Electronic Engineering Solutions), CASE, and PLM [2]. These tools produce data about the product model and product structure that are incompatible with one another. Diversity of data from different disciplines brings some challenges, which can be pointed out in the following:

- 1) It is difficult to show, understand, and construct the interdisciplinary and functional relationships between the different systems and components.
- 2) Increasing the efficiency of directing and organizing the design development process can be achieved by making use of the information extracted from product models.
- 3) The imprecision and incompleteness of the design requirements pose challenges in the product data analysis and exchange.

A. Early Design in the development process

In the early stages of the design process, the data of product models are used to describe the links, connections, and interfaces of product elements, and functions of the various domains in an abstract way. The necessity of viewing the

integrated complete mechatronic systems alongside the interfaces and connections between the different disciplines throughout the entire design development process is vital. Also, a common language is essential in order to enable traceability, and reasoning between the different components and functions.

B. Functional Modeling

Functional modeling provides a high-level system view specifying the functionality of the product from the product description. Functional modeling is the specification of models that describe the function and the functional relationships as objects and relations to the development process. Through functional product modeling, a solution-independent and abstract representation of a task to be created can be represented [3]. For this reason, function modeling is considered when modeling on a conceptual level, where functions can be drawn from the realization of different customers' requirements [4]. This abstraction of the basic concepts using the product function is used in many areas and is supported by suitable development tools, especially in electrical, electronic, hydraulic, pneumatic and software development.

Functional model was not originally established for the support of computer-aided modeling and design, where it is considered as a model-based approach. The development of the functional model throughout the design process is through documents only [5].

The formulation of functional basis for the functional models was needed to step towards model based functional design. Therefore, a contained controlled vocabulary was developed for functional modeling in the design knowledge repository. It consists of 53 functions (in a verb form), and 45 flows (in a noun form). Each of the functions, and flows

are structured in a three-level hierarchical taxonomy [6]. The most abstract forms are at the highest level, which is called “primary class”, e.g. branch, channel, or convert for functions, and energy, material, and signal for flows.

C. System Engineering

Model-based Systems Engineering (MBSE) is a multi-disciplinary approach to help understand the context and specification to satisfy the specified customer requirements by developing system solution in response to the different needs of stakeholders [7]. Aspects of MBSE includes behavioral analysis, system architecture, requirements traceability, performance analysis, system simulation, test, etc. [8]. There are a large number of process models, methods and tools for supporting model-based development. The system is usually modeled using UML (Unified Modeling Language) and System Modeling Language (SysML). They are widely used modeling languages for the aid of the MBSE, which are provided by the Object Management Group’s System Modeling Language [9].

System Modeling Language (SysML) is an extension of MBSE and can be utilized as a computational mechatronic product model. However, there is still a lack of acknowledgement and practice of MBSE in industry, which points out that there is a need for further development of MBSE in terms of usability [10]. Therefore, the following criteria need to be fulfilled:

- 1)The models must display the abstract mapping of the product functions, activities and components, and their dependencies. They should also provide information about the internal changes between the disciplines to aid in the product’s development process.
- 2)The models may, also, be able to contain meta-model information, in which the traceability, and reasoning between systems, sub-systems, and components are permitted.
- 3)Product model’s data should participate in the advancement, guiding, and organizing the process development models.

II. DATA MANAGEMENT IN PRODUCT MODELS

STEP, which stands for STandard for the Exchange of Product model data, is known as the ISO 10303 [11] standard. Application Protocol (APs) is a part of STEP that specifies the scope, context, and information requirements of STEP. Different parts of STEP APs are used for different engineering domains, i.e., AP 203, AP 209, and AP 214 are used in Mechanical design. AP 233 are used for the data exchange of the product data and information in system engineering and it is used in many industries such as: Aerospace, automotive, shipbuilding, etc [11].

AP 233 defines the element of a system that interact with other systems as a connector. While the link between two connectors are defined as a connection [12]. However, no further details are given for the description of connections, and connectors. [13] integrates UML with AP 233 in order to provide more detail information about the interface connections and connector. But this work is only limited to software engineering. [1] proposes a multidisciplinary interface model to aid the multidisciplinary integration. His work provides a structural representation of the interface in order to be able to store information about the model data for future knowledge reuse. Three aspects of the interface are defined: Type (geometry, energy, control, or data), configuration (to describe what elements are linked), and desired/undesired (weather the link creates positive or negative effect).

[13] proposes data scheme for functional product description, where SysML model capabilities are integrated. This data scheme benefits from the abstraction level of the design and provides the information between the requirement, functional, and logical levels. However, the compatibility rules are not enforced to guarantee a correct integration. [14] develops a consistency check between the object flows of the functional model in SysML. In his work, the ports between the two systems have to match, i.e. energy to energy, material to material, or signal to signal. A detailed port description for the different object flows are not defined.

This work will develop data modeling in SysML for the data management in the functional model. It will provide a detailed description of the object flows in SysML and, at the same time, guarantees a compatible port matching.

III. DEVELOPMENT OF DATA MANAGEMENT FOR FUNCTIONAL DESCRIPTION OF PRODUCT MODELS

The scope of this study is the functional product description, since functional model is the heart of the conceptual design phase of the mechatronic design process. Moreover, as this study focuses on the data exchange of the product model, the aim is to model the object flow, whereas the object functions will be outside of the scope of this work.

A. Object flows

Object flows are defined as the input and output of a function. They are used for the data and information exchange between the different functions. [6], [15] classified three basic flows in any design problem; Energy, Material, and signal. These flows are specified more accurately in the form of vocabulary and each basic flow is categorized into primary, secondary, and tertiary (or class, basic, sub-basic). The vocabulary are used to describe the

flow in a high-level of abstraction and with of development of the flow categorization, more accurate description can be achieved.

B. Modeling in SysML

SysML aims to provide a language that enables to capture the different aspects of the information about a system in an integrated model. This would increase the communication between the different aspects of the model, and it decreases the ambiguity between the designers and stockholders. Moreover, SysML has the capability for model system interfaces with different types. Interface model of SysML v1.3 retain all the capabilities from SysML v1.2 and provides additional capabilities.

Object Modeling Group (OMG) are working for the development of STEP AP 233 within SysML by performing a mapping of the data construction between them.

Previous work used hierarchical structures to model the data exchange between different level of the early. Stage of the development process; namely between requirements, functional, and logical levels. Even though, hierarchical structure provides a good overview of the of the system, and close the gap and understanding between them, however, it doesn't consider the internal data structures among each system level.

C. Integration of object flows in SysML for functional model description

The link between functions in the functional level is performed according the functional basis mentioned previously. For the modeling of the different categories of the class flows in SysML, the development of ports are introduced next.

Ports in SysML v1.3 is represented here as the interface of functions with other functions or with the environment. Each port can be specified with a type and, therefore, are called typed ports. Three types of ports are proposed for the representation of the object flows: flow ports, full ports, and proxy ports.

Flow ports are typed by flow specifications and they are introduced here for the representation of Energy flow class. The details of basic and sub-basic description of the flow class can be contained in the flow specifications, which specifies the types of flow coming in or out of a function.

Full ports are typed by a block, where it is presented here for the modeling of Material class. Full ports are used for the representation of a part of a system, in which the information of the Material class are stored inside the block. Proxy ports are typed by an interface block. It is used for the representing the Signal class as it specifies which features are accessible and it cannot have behavior or internal parts.

D. Port Compatibility

The connection between the different types of ports should be done without violating the constraints. The compatibility between the ports is based on port type, name, and direction. Proxy ports does not require a compatibility check as it can provides signal/information to all other port types.

IV. APPLICATION EXAMPLE: CONVEYOR SYSTEM

An electro-mechanical conveyor system falls within the category of a mechatronic system. In the present case study, such a system that is used to transport fish from the feeding station to the cutting station in a fish processing machine is considered [22] (Fig. 4). Conveyor systems are widely used in fish processing machines in order to provide an intermittent motion for the fish during transportation. The motion profile is planned in such a way that the cutter has sufficient time to cut the head of each fish with minimum meat wastage, while the fish is kept stationary. Furthermore, the fish has to be held firmly during the transportation and cutting operations.

Many considerations have to be addressed in the design of a conveyor system. In the present example, a main objective of the conveyor system design is to cut the fish head rapidly (e.g., a cycle time of two seconds) and accurately. Also, the system has to operate under medium to light-duty load, and must have a medium to low cost.

The main functional requirement of the drive system is to "produce intermittent motion" of acceptable characteristics. The main function can be modeled as a black box with inputs and outputs. The input flows to the main function are human energy, electrical energy, and solid material. Human energy represents the energy for human interaction to turn the machine on, feed the fish at the inlet of the conveyor, and monitor the machine operation. The electrical energy includes the electrical power supply to the motors, hydraulic system, and other hardware. The solid material is the fish. There is only one output, which is solid and represents the processed fish. Subsequently, the main function of the conveyor system is decomposed into sub-functions arranged in sequential and parallel structures. At the same time, the inputs and the output should be preserved. Fig. 5 shows the functional structure of the "Produce intermittent motion." The functional structure offers a discipline- and solution-nature view [25]. The electric energy is used to drive the conveyor because of the advantages of using an AC motor. They can provide low cost, speed variation, high power factor, and high reliability.

In order to computationally model the multidisciplinary interface for the functional description of the product model, Magicdraw 18.5 will be the platform software for the

SysML modeling. Figure () shows the functional model that was created using the Internal Block Diagram (IBD) with the functions indicated in boxes. The ports indicates the interfaces of functions with each other and are indicated in small boxes attached the functions and provided the incoming and outgoing of Material, Energy, and Control signal.

In Fig (), the port type indicates the flow class. For example, the ports with an arrow indicated the Energy class. Moreover, each port is further described by additional information for the basic/secondary level of flow information

A. Compatibility Check

The computational model capability is able to automatically check for the compatibility rules. For example, if the flow is entering the function, while the arrow of the flow port is pointing to the outside, an automatic error message appears. Also, if the material type is different from the outgoing port than the incoming port, an automatic error notification will take place. This is shown in Fig ()

REFERENCES

- [1] C. Zheng, P. Hehenberger, J. Le Duigou, M. Bricogne, and B. Eynard, "Multidisciplinary design methodology for mechatronic systems based on interface model," *Research in Engineering Design*, vol. 28, no. 3, pp. 333–356, 2017.
- [2] M. Abramovici and F. Bellalouna, "Integration and complexity management within the mechatronics product development," in *Advances in Life Cycle Engineering for Sustainable Manufacturing Businesses*, Springer, 2007, pp. 113–118.
- [3] A. Albers and C. Zingel, "Challenges of model-based systems engineering: A study towards unified term understanding and the state of usage of SysML," in *Smart Product Engineering*, Springer, 2013, pp. 83–92.
- [4] B. Kruse, C. Münzer, S. Wölkl, A. Canedo, and K. Shea, "A model-based functional modeling and library approach for mechatronic systems in SysML," in *ASME 2012 International Design Engineering Technical Conferences and Computers and Information in Engineering Conference*, 2012, pp. 1217–1227.
- [5] M. Eigner, T. Gilz, and R. Zafirov, "Proposal for Functional Product Description as Part of a Plm Solution in Interdisciplinary Product Development," in *DS 70: Proceedings of DESIGN 2012, the 12th International Design Conference*, Dubrovnik, Croatia, 2012.
- [6] R. B. Stone and K. L. Wood, "Development of a functional basis for design," *Journal of Mechanical design*, vol. 122, no. 4, pp. 359–370, 2000.
- [7] M. Eigner, T. Gilz, and R. Zafirov, *Interdisciplinary Product Development-Model Based Systems Engineering*.
- [8] L. E. Hart, "Introduction to model-based system engineering (MBSE) and SysML," in *Delaware Valley INCOSE Chapter Meeting, Ramblewood Country Club, Mount Laurel, New Jersey*, 2015.
- [9] O. M. Group, *OMG Systems Modeling Language (OMG SysMLTM)*. 2008.
- [10] J. E. Kasser, "Seven systems engineering myths and the corresponding realities," in *Systems Engineering Test and Evaluation Conference*, (Adelaide, Australia), 2010.
- [11] M. J. Pratt, "Introduction to ISO 10303—the STEP standard for product data exchange," *Journal of Computing and Information Science in Engineering*, vol. 1, no. 1, pp. 102–103, 2001.
- [12] U. Sellgren, M. Törngren, D. Malvius, and M. Biehl, "PLM for mechatronics integration," in *Proceedings of the 6th International Product Lifecycle Management Conference (PLM 2009)*, 2009.
- [13] A. Pandikow, E. Herzog, and A. Törne, "Integrating systems and software engineering concepts in AP-233," in *Proceedings of the 2000 INCOSE Symposium*, 2000, pp. 831–837.
- [14] B. Kruse, "A Library-Based Concept Design Approach for Multi-Disciplinary Systems in SysML," *ETH Zurich*, 2017.
- [15] J. Hirtz, R. B. Stone, D. A. McAdams, S. Szykman, and K. L. Wood, "A Functional Basis for Engineering Design: Reconciling and Evolving Previous Efforts," *Research in engineering Design*, vol. 13, no. 2, pp. 65–82, 2002.

A survey investigation for the Corruption in Iraqi Construction Projects

^[1] Abdunnasser M. Abbas, ^[2] Haleem K. Hussain, ^[3] Ahmed Sagban Saadoon
^{[1][2][3]} Dept. of Civil Engineering, College of Engineering, University of Basrah, Iraq

Abstract: -- Corruption is the major threaten to the societies, especially in developing countries. It has changeable aspects, among these, that which related to the construction projects. This study presents a survey tested respondent's opinion on corruption of construction projects in Iraq. The survey based mainly on the persons who have personal experience and work in a miscellaneous strips concerning to this field, they divided into three groups; these are university professors (lecturers), engineers and contractors. The majorities of responding who participate strongly in the survey are the engineers; however, the university lecturers come in the second grade, and finally the contractors. The essential objective of this study is to identify the reality of corruption in the Iraqi construction projects and attempting to determine some solutions to minimize this serious issue.

Index Terms—Corruption, Constructional, Project, Iraq.

I. INTRODUCTION

The International transparency is a non-governmental organization ranking the global world countries according to the corruption perception index, which is depend mainly on the score of each country. This score is varied from 0 to 100, when the corruption index decreases; this score increased to reach near 100 which mean that the country is very clean from corruption.

Unfortunately, the international transparency in 2017 puts Iraq in a rank of 169/180 with a score of 18/100 [1], this indicates that Iraq is one of the most corrupted countries in the world.

Actually, the corruption pest is not existing in a single sector of the country, it affects all the society aspects. Corruption may be existed as a bribe, Embezzlement, Kickbacks and fraud. However, the dangerous field that the corruption acts on is the construction projects, which costs the country huge amount of money. Therefore, this study conducted to present a specified view on some problems on the corruption of the construction industry in Iraq. In this study, a questionnaire consisting of more than 25 items was prepared and submitted to a community slice worked in the construction projects, they are university lecturers, engineers and the contractors that are working in the construction industry. This study is aimed to improve the awareness against the corruption to construct a basis suitable of the infrastructures in Iraq.

II. LITERATURE REVIEW

The definition of corruption that stated by the United Nations is offering, giving, extradite or petition, explicitly or in explicitly anything of worth to affect the behavior of a formal in the procurement or picking operation or in construction contract fulfillment [2].

Over the few decades, many studies have considered on the corruption, in the United Kingdom it is found by CIOB [3] that 51% from a slice consists above 1000 respondents had direct experiments of corruption, and at least on a single opportunity, 41% of the practitioners directly or indirectly offered a bribe. Corruption, as the study found, exists in more than one aspect of the UK construction projects, and hence, to minimize corruption to the lower levels, more action must be done by the government. Thereafter U.K. government responds by introducing the Bribery Act [4] which is become effect in April 2011; this act requires construction associations to confirm their obligation to struggling corruption [5]. However, the Bribery Act [4] carries on company's senior officials the liable for non-resisting corruption.

In fact, Corruption may appear at any stage of the project such in planning, design, inspection, bidder and signing of contract, construction, service providing with operation and finally, the maintenance process as shown in table (1) [6]. Construction industry is known as one of the biggest industries in the whole world [7], However, as compared with the other sectors of industry, constructions projects possess an encouraging credit because it is generally

associated with collapse of business and regarding to minimum records linked with incomplete projects because of many matters such as time exceeding and cost, high scale of disputes, and the market environment are highly competitive [8], [9]. In the meantime, there are many factors that affect the construction industries, such as various kinds of stakeholders (designers, employers, suppliers, contractors...etc.), different resources (materials, equipment and labor), political and complete design, and managerial factors and economic, all these factors make the construction industry one of the riskiest business [10].

On the other hand, there are many features that make the sector of construction prone to corruption, these are: 1. Competitive; 2. A huge number of subcontractors; 3. A lot of permits and approvals; 4. It is difficult to contrast pricing of projects when they presented individually; 5. The opportunities for retards and overtakes; and finally 6. The fact that the quality of work may be concealed [11].

Table 1: Corruption forms in the construction project cycle [6]

Stage of service delivery	Examples
Planning stages	<ul style="list-style-type: none"> Project used as vote winners/opportunities for personal gain not on basis of priority/availability of financial resources. Planning in favour of high value infrastructure (white elephant projects) and against the interest of the poor.
Inspection stages	<ul style="list-style-type: none"> Bribing inspectors.
Design	<ul style="list-style-type: none"> Corrupt selection of consultants for feasibility studies, preparation of specifications/bid documents. Over designed and overpriced projects. Bribe for favourable environmental impact assessment/planning proposal/approval.
Bid and contract signing Stage	<ul style="list-style-type: none"> Kickbacks for construction and supply contracts. Lack of competitive/inequitable contract practices. Entertainment. Corrupt civil servants selling recommendations for contracts. Politicians influence choice of contractors or nature of contract.
Construction	<ul style="list-style-type: none"> Changing subcontract party after receiving bribes. Misuse of vehicles and funds. Cutting corners, ignoring rules, by passing procedures Payment for equipment, materials or services which were not supplied. Concealing substandard work. Bribe the relevant official to certify that the work was done according to specification. Non-implementation.
Service delivery	<ul style="list-style-type: none"> Ghost/absent workers. Siphoning off supplies to market. Favouritism in hiring/promotions Use of contacts/money to get better/faster service. Elite capture of infrastructure services.
Maintenance and management stages	<ul style="list-style-type: none"> Corruption in procurement of equipment and spare parts. Withholding needed approval/signatures of gifts/favours. Corruption increases costs meaning lack of resources for O&M. Bribes to win O&M contracts/ personnel appointments. Lower standard of construction creates need for expensive repair and maintenance.
Subscription process	<ul style="list-style-type: none"> Consumers pay money in order to speed up the process. Extra-legal payments for new connections. Officials are paid to turn a blind eye to unauthorized connections.
Billing system	<ul style="list-style-type: none"> Opaque system of billing. Irregularities in ledger of paid bills.
Disconnection	<ul style="list-style-type: none"> Disconnecting customers in good standing. Extorting money to reconnect. Extorting money to prevent disconnection.
Fault redress	<ul style="list-style-type: none"> Extorting money for repairs that are meant to be free. Gift giving in return for favours in fault redress.

III. TYPES OF CORRUPTION

Briberies are highly common, especially in the developing countries, it consists of gratuities and gifts, the use of mediators and hospitality [12], [13].

Fraud is defined as economical crime includes different acts such as trickery, swindle, deceit or misinformation [14], [15].

Kickbacks are unlawfully rewards paid to gain a decision for an individual has power position, like selection of contractor [16]-[18].

Collusive tendering is defined as a secret pact between many sides to a fraudulent. While, bid rigging appears when the former makes criteria so as to gain the contract by the preferred tenderer [19].

Embezzlement appears when an official scrounges or purposely misapplies project funds for political spoil or an individual reward [20]. On the other hand, the outcomes of embezzlement consist of overdue or nonpayment of suppliers and contractors, uncompleted projects, and low-standard workmanship.

Fronting appears if an official inside government proxy or client organizations which produce front associations so as to gain construction contracts. In the meantime, these companies earn illegal or unfair interests in awarding the public contracts due to the powerful positions of owners in the government [21], [22]. Then, these contracts are authorized to another construction companies for personal gain.

IV. RESEARCH METHODOLOGY

There are many advantages of data gathering by the questionnaire method; first of all, it supplies dependable and adequate information, secondly, it offers huge anonymity, because there are no eyes contact between the respondent and the interviewer, and finally, it is a suitable method that used when explores about critical subject such as corruption. In the recent work, a questionnaire method was used to collect the required data, a prepared questionnaire was submitted to the society slice that works or involved in the construction projects; they were lecturers at the college of engineering, engineers and constructional contractors. The presented questionnaire consists of general information about the respondent, multiple choice questions. Figures 1 to 4 illustrate general background about the respondents.

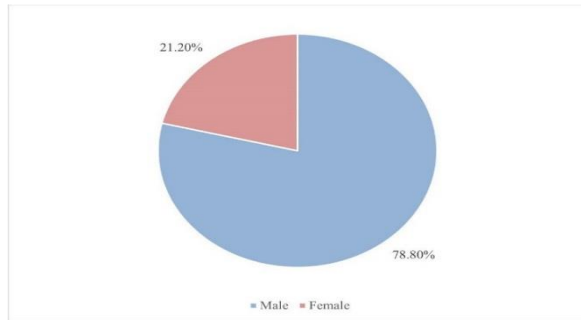

Figure 1: Respondent Gender

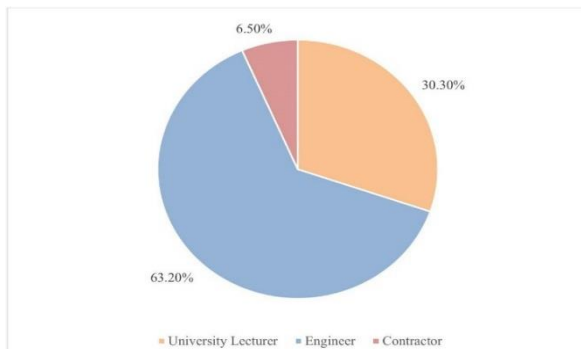

Figure 2: Respondent Job title

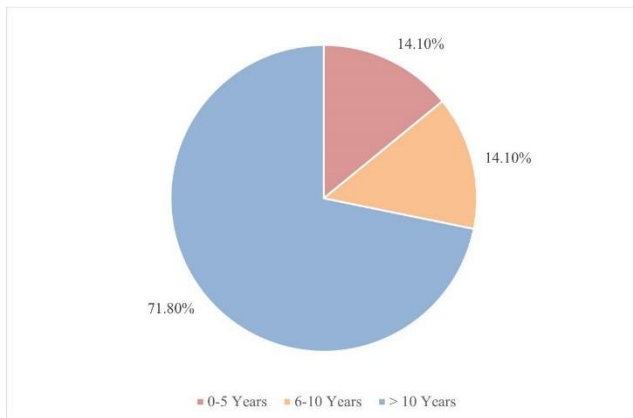

Figure 3: Year of service for respondent

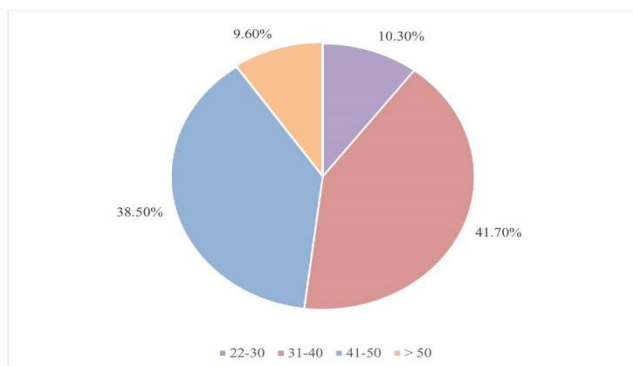

Figure 4: Respondent age

V. DISCUSSION OF RESULTS

In the recent investigation, a survey was embodying of at least 155 respondents. They gave their opinion on the corruption at the constructional projects. Unfortunately, 73.1% of the respondents believe that corruption nowadays becomes a general culture, on the other side 10.9 % of them did not accept this idea, while the rest of them was suspicious of this issue. About 85.2 % of them believe that there is a huge corruption in the constructional projects, while 12.9 % of them suspect of the corruption existence, and 1.9 % deny this idea. There are two sides that responsible for managing the projects, the implemented company and the supervised company. There are 92.9 % of respondents insist that both of them are share in the corruption, while 3.9 % and 3.2 % thinks that the responsibility is on the supervisor and implemented companies respectively.

On the other side, constructional materials should be well tested according to the standard specifications. Therefore, respondents have answered many questions concern about this section. About 50.8 % of them thinks that the constructional materials are may be tested according to the standards specification, while 31.0 % said that the tests are done inadequate manner, while the rest prefer to be on the opposite side. The other problem is that, are the whole taken samples of the construction materials are tested? In this matter, 23.5 % of the respondent says yes, while 37.9 % and 38.6 believe that the whole taken samples were not tested or may be tested.

Corruption in the construction site may be done by manipulating the quantities and cheating in the quality of the construction materials. Table 2, shows the respondents opinion, which is given the worst impression about that. The results show that most of the participants believe that the manipulating in the quantitates (59.4%) and cheating in the quality of the constructional materials (64.1%) exists.

Table 2: Corruption due to manipulating and cheating

Question	Believe in %	Not believe %	Suspicious %
Is there any manipulating in the quantities that used in construction projects?	59.4	6.4	34.2

A survey investigation for the Corruption in Iraqi Construction Projects

Is there any cheating in quality of the used construction materials?	64.1	3.2	32.7
--	------	-----	------

In order to conduct the diversity of the respondent opinions, a set of questions was provided with a scale from 1 to 5 (1, weak, 2. Medium, 3. Good, 4. Very good, 5. excellent), as shown in Table 3. In this table, it can be seen that most of the answers were varied between the weak and intermediate, the cooperation in the project site between the engineers and the employee or between the university lecturers and the engineers is not in the adequate level. This will create a weak society at the project and therefore allow to increase the indifference of the public interest and maximize the opportunities of corruption.

Table3: Five scale questions

Question	1	2	3	4	5
Cooperation extent between the engineers	27.7	47.7	20.6	2.6	1.3
Cooperation between engineers and workers	20.1	44.2	27.5	6.0	2.0
Quality of the resident engineer in the project	20.1	55.2	20.8	1.9	1.9
Quality of workers	27.9	61.0	9.1	1.3	0.6
Cooperation between the engineers and university professors?	53.3	32.9	9.7	3.2	0.6

A part of work of this investigation, an interview was done to explore more reasons about the corruption in the construction projects, and the results could be listed as follows:

The circle of the resident engineer not working effectively, and some of these engineers are new and not have the adequate experience, they may be not able to take a serious decision because they afraid if they take this step, they may demobilize.

There are bribes and a covert understanding between the administration staff and the construction contractors against the resident engineer which makes the circle of the resident engineer weakened.

Nowadays, there are many of the so-called turnkey projects, in which, the contractor provides all of the designs and quantities tables. Unfortunately, most of these documents are missing the required laboratory tests for completion of the infrastructure structures, such as water and sewage projects. In such circumstances, many of construction errors are always buried under the ground.

VI. HOW CAN CORRUPTION BE MINIMIZED

There is an undeniable fact that corruption is one of the social phenomenon which is deep rooted in the mankind history. It is like many crime patterns that may take place in the work procurements via governments and regional authorities, as a reason of a huge of money that participates in one purchase while monitoring of the project expenditure is difficult. So that, it is necessary to create strategies to reduce any corruption hazard and corrupt attitude in the construction projects [23]. In this survey, some strategies to minimize corruption was presented as shown in Table 4 and Figure 5. From the results that obtained from the survey, Figure (5), it can be shown that most of the participants prefer the factors A4 and A7 which have more than 70 % of their opinion. While factors A1, A3, A8 and A9 becomes in the second degree, the rate of these factors varies from 60 % and 70 %. However, the less factor that has been the record is A5. About this issue, a question was asked of the participants about their involvement in any awareness sessions against corruption, the answer was disappointing because of 87 % of them not involved in such sessions.

Minimizing corruption in construction projects is not easy but it is possible, it should take the factors that listed in Table 3 seriously, and educate the staff members and the society about the risk of corruption, and explain how the life will be if we minimize corruption, like in the developed countries, the corruption exists but in lower levels, but many services for their people are offered and many of them live in approximately high living standards.

Table 4: Activities should be taken to reduce corruption

Factor	Activity
A1	Activation of committees monitoring form the beneficiary side
A2	Conduct periodic visits to the project's site by the

A survey investigation for the Corruption in Iraqi Construction Projects

	experts
A3	Increase the unannounced visits to the project site
A4	Certifying the engineering designs by qualified consultants
A5	Force the staff to participate in awareness sessions against corruption
A6	Certify the contracts by a neutral party
A7	Activate the sanctions system against the violators
A8	Activate the incentive system according to the working hours
A9	Exploitation of working hours in an appropriate manner

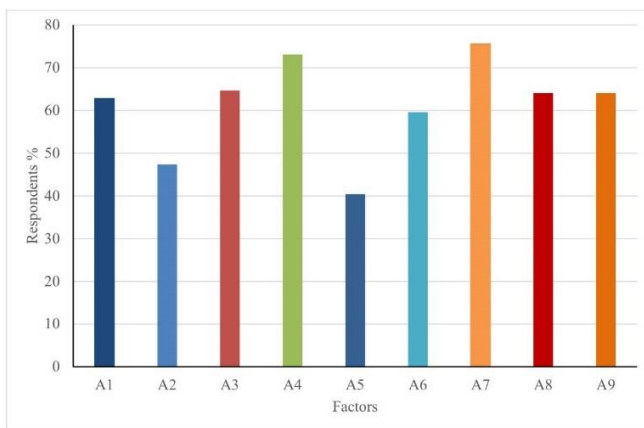

Figure 5: How to minimize corruption (respondent opinions)

VII. CONCLUSION

Corruption is a community scourge. In fact, it cannot be totally terminated, but we seek to minimize it in such a way that not effect on the people life. This may be done by a serious cooperation between the government and the community. The main concluded activities are as follows:

1. Increase the unannounced visits to the site of the construction projects.
2. Activate the sanctions system against the violators.
3. Activate the incentive system according to the working hours.
4. Force the staff to participate in awareness sessions against corruption.

5. Provide a resident engineering circle with an adequate experience and powerful in making decisions.

REFERENCES

- [1] International Transparency, 2017 Transparency International. (2016). "Corruption perceptions index 2016." http://www.transparency.org/news/feature/corruption_perceptions_index_2016i (Feb. 8, 2017).
- [2] UN 2006, p. 4-36 UN (United Nations). (2006). "UN procurementpractitioners'handbook." <https://www.ungm.org/Areas/Public/pph/channels/PPH.pdf> (Nov. 2, 2015).
- [3] CIOB (Chartered Institute of Building). (2006). "Corruption in the UK construction industry. (<http://www.ciob.org.uk/document/corruption-uk-construction-industry>) (Jul. 5, 2016).
- [4] The Bribery Act, 2010 Bribery Act, 2010, c. 23 (U.K.).
- [5] Donohoe, S. (2011). "The Bribery Act 2010: Implications for building surveyors." *Struct. Surv.*, 29(1), 26–34.
- [6] Sohail, M. and Cavill, v, 2016 Corruption in construction projects WEDC, Loughborough University, Leicestershire, LE11 3TU, UK, 2016.
- [7] Nunnally S. W., Construction Methods and Management, 7th Edition, University of Florida, 2007.
- [8] Barrie, D. & Paulson, B. C., 1992. Professional Construction Management. USA: McGraw-Hill.
- [9] Cooke, B. & Williams, P. N., 2009. Construction Planning, Programming and Control. 3rd Ed. Chichester; Ames,IA: Wiley-Blackwell.
- [10] Al-Sayegh, S. M., 2008. Risk assemssent and allocation in the UAE construction industry. *International Journal of Project Management*, Volume 26, pp. 431-438.
- [11] Stansbury, N. (2005) Exposing the foundations of corruption in construction. In *Global Corruption Report (2005) Special Focus: Corruption in Construction and Post Conflict Reconstruction*.
- [12] Gordon, K., and Miyake, M. (2001). "Business approaches to combating bribery: A study of codes of conduct." *J. Bus. Ethics*, 34(3-4), 161–173.

[13] Amundsen, I. (2000). "Analysis and definition of corruption and its common forms." U4 Anti-Corruption Resource Centre, Bergen, Norway.

[14] Tabish, S. Z. S., and Jha, K. N. (2012). "The impact of anti-corruption strategies on corruption free performance in public construction projects." *Constr. Manage. Econ.*, 30(1), 21–35.

[15] Vee, C., and Skitmore, R. M. (2003). "Professional ethics in the construction industry." *Eng. Constr. Archit. Manage.*, 10(2), 117–127.

[16] Alutu, O. (2007). "Unethical practices in Nigerian construction industry: Prospective engineers' viewpoint." *J. Prof. Issues Eng. Educ. Pract.*, 10 .1061/(ASCE)1052-3928(2007)133:2(84), 84–88.

[17] Sohail, M., and Cavill, S. (2008). "Accountability to prevent corruption in construction projects." *J. Constr. Eng. Manage.*, 10.1061/(ASCE)0733 -9364(2008)134:9(729), 729–738.

[18] Osei-Tutu, E., Badu, E., and Owusu-Manu, D. (2010). "Exploring corruption practices in public procurement of infrastructural projects in Ghana." *Int. J. Manag. Projects Bus.*, 3(2), 236–256.

[19] Le, Y., Shan, M., Chan, A. P. C., and Hu, Y. (2014). "Overview of corruption research in construction." *J. Manage. Eng.*, 1061/(ASCE)ME .1943-5479.0000300, 02514001.

[20] Hartley, R. (2009). "Fighting corruption in the Australian construction industry: The national code of practice." *Leadership Manage. Eng.*, 1061/(ASCE)1532-6748 (2009) 9:3 (131), 131–136.

[21] De Jong, M., Henry, W. P., and Stansbury, N. (2009). "Eliminating corruption in our engineering/construction industry." *Leadersh. Manage. Eng.*, 10.1061/(ASCE)1532-6748(2009)9:3(105), 105–111.

[22] Bowen, P., Akintoye, A., Pearl, R., and Edwards, P. J. (2007). "Ethical behaviour in the South African construction industry." *Constr. Manage. Econ.*, 25(6), 631–648.

[23] Patrick X.W. Zou, Strategies for Minimizing Corruption in the Construction Industry in China, *Journal of Construction in Developing Countries*, Vol. 11, No. 2, 2006

Optimization of Parameters for Student Assessment Using Response Surface Methodology

^[1] Aruna M., ^[2] Rashmi Rani

^{[1][2]} College of Engineering and Computing, Al Ghurair university, Academic city, Dubai.

Abstract

This work is concerned with optimization of the student test scores while taking Tests and Final exam in two different courses, Numerical methods in Engineering and Mathematical methods. Optimization of test scores is very beneficial to predict the correlation between them. The tactic is based on Response Surface Method (RSM). Second-order quadratic models are developed for test scores, considering the Assignment, Quiz and work sheet as the parameters, using central composite design. Central composite design (CCD) is an approach to an experimental matrix in order to show the applicability of design of experiments methodology to the evaluation scheme. Three factors have been analyzed in terms of their impact on the score of the student. The developed models are used to determine the optimum evaluation parameters. The implication of the tested factors over their particular ranges has been evaluated using the ANOVA and by the consideration of the coefficients of the model equation. These optimized evaluation parameters are validated experimentally, and it is observed that the response values are in reasonable agreement with the predicted values.

Keywords: Optimization, Assessment marks, ANOVA, Response Surface Methodology (RSM), Central composite design (CCD)

1. INTRODUCTION

Enlightening student's academic performance is not an easy task for the academic community of higher education. Quality of the academic structure must be regularly examined, specially under conditions of growing competition and limited resources. Those who are concerned in quality, doing research and teaching on it, should ensure quality of the procedures for which they are accountable. Teaching is one of the prime services offered by a university. Normally, teachers use tests to evaluate students' knowledge acquisition. The teaching of mathematics, which is the toughest means for the order and organization of the developing world, and acquisition of mathematical skills has become more important than before (Betz, 1978). According to the information by United States National Research Council (1989), simple skills of Mathematics and geometry are essential for specialization in the seventy-five percent of all occupations. Tobias (1978) emphasized the importance of basic high school mathematics knowledge in the examinations done for recruitment in the public and private sectors. When the "education level" in Mathematics which has such significance for society and human life is considered, this level cannot be said so amusing. The outcomes of the examinations done nationally and internationally show that students are not efficacious enough especially in the field of Mathematics (Berberoglu, 2007). The results of the examinations held and research works applied both in examinations and assessments.

Examinations have a vital place in an individual's teaching practice (Semerci, 2007). Bianchi, Stobbe, and Eva (2008) were concerned in comparing the academic performance of students studying at rural versus urban settings. These researchers used ANOVA to inspect group differences on multiple types of assessment scores.

With the improved emphasis on experimental design, response surface methods have received considerable attention in recent eras. RSM is a collection of mathematical and statistical techniques that are useful for modeling and analysis of problems in which a response of interest is influenced by several variables and the objective is to optimize this response (Myers, 1995). The RSM is one of the design of experiments (DOE) methods used to approximate an unknown function for which only a few values are computed. Current case studies of RSM optimization of stochastic simulation are presented by Irizarry et al (2001); a case study of RSM for deterministic simulation is offered by Ben-Gal and Bukchin (2002). Optimization in simulation has been attempted by many methods; Fu (2002), Tekin and Sabuncuoglu (2004), and Kleijnen (2008).

Formative assessments, that measure student's performance have been widely hailed as a potential vehicle for improving student achievement. Yet little solid research evidence exists about their effectiveness, especially in mathematical courses. This study examines the effects of the Assessments of Student initiative in the university, where the use of data to improve instruction is a general priority. The

study looks at changes in reading scores over time at 2 courses that operated serving demographically similar students during the same period.

The methodology is based on the concurrent use of teaching experiments performed by a teacher, and the Regression model for the evaluation of student grades. RSM methodology can be implemented in any educational framework. It is a suitable tool for continuous course improvement. The article presents the application of RSM methodology in two consecutive courses namely Numerical methods in Engineering and Mathematical methods. The RSM was then used to analyze student efforts at exams. Our goal was to gain insight into factors that may be related to students successfully designing experiments. The instrument guides teachers and researchers in assessing seven main components of experimental designs. This article explores competencies and approaches for their assessment in higher education.

2. METHODOLOGY

In this novel experimental study, we examined whether Assignment, quiz and work sheets can be used to foster students' learning of two mathematical courses in BSME course. The analyses in this study include test scores from two different courses taken during a semester.

Despite their potential for improving students' achievements, little rigorous research has been done on the impacts of formative assessments. This report presents the findings of RSM analysis to shed light on the assessment of mathematical courses in BSME Program during the study period.

Review in Assignment, quiz and work sheets produced the greatest increases in exam performance, and these increases were only slightly augmented when the items had appeared on previous assessment factors. The benefits of Assignment, quiz and work sheets persisted on end-of-semester exams. We suggest that the present effects reflect benefits accruing to retrieval practice, benefits that are well established in the basic literature.

This most maligned index can be used in studies of change, growth, or perhaps discrepancy between two measures taken on the same sampling unit. The most commonly stated problem with difference scores is the supposed associated increase in unreliability of difference scores. In this article, the authors examine difference scores from the point of view of repeated-measures ANOVA. The approximating model is based on the observed data from the process or system and is an empirical model. Multiple regression as a collection of statistical techniques is useful for building the types of empirical models requisite in RSM.

This study investigated the feasibility of the use of the three-parameters, Assignment, quiz and work sheets. Table 1 depicts the assessment parameters and their levels.

Table 1 Assessment parameters and their levels

Factors	Levels		
	Low	Average	High
Assignment	2	10	20
Quiz	1	5	10
Work sheet	2	8	15

College undergraduates (N=20) enrolled in 2 mathematics courses, Numerical methods in Engineering and Mathematical methods are considered for this study. The final marks are set for 30 marks. These tests focus mainly on mathematical skills. The central composite design is used, since it gives a comparatively accurate prediction of all responses vs averages and the results from the assessment performed is given in Table 2.

2.1. Empirical model

Examination of the fit summary output reveals that the Quadratic model is statistically not significant for the results Numerical methods in Engineering and Mathematical methods. An ANOVA table is commonly used to summarize the test performance. Analysis of variance (ANOVA) was performed on the test scores as shown in Table III and Table IV. ANOVA table depicts the response surface quadratic model for student assessment. It's obvious from the results of ANOVA that the Assignment is the dominant factor affecting Numerical methods in Engineering. The contribution of Quiz and worksheets are 0.3248 and 0.1395. Quiz is the foremost feature affecting Mathematical methods. The contribution of Assignment and worksheets are 0.1167 and 0.0091 respectively. The interactions AxB, AxC and BxC are not significant for both courses. To understand the assessment process in terms of two courses, empirical equations are developed using multiple regression method and the models are referred below as (1) and (2).

Numerical Methods in Engineering	9	2	1	2	12.5	15.5
= (+22.35903)	10	26.1361	5.5	8.5	17	16
* (-2.86233 Assignment)	11	11	5.5	19.4317	15	14
* (+1.02346 Quiz)	12	20	10	2	12.5	8
* (+ 0.670680 Work sheet)	13	2	1	15	26.5	21.5
* (-0.062500 Assignment * Quiz)	14	11	5.5	8.5	17	13.5
* (-2.56250 Assignment	15	20	1	15	29	26
* Work sheet)	16	11	5.5	8.5	28.5	26
* (0.937500 Quiz * Work sheet)	17	11	5.5	8.5	29.5	20
* (-1.70003 Assignment ²)	18	2	10	2	21	14
* (-1.25809 Quiz ²)	19	20	10	15	9.5	16
* (-0.020653 Worksheet ²)	20	11	5.5	-2.4316	20.5	27

(1)

Mathematical Methods

- = (+ 20.19255)
- * (- 0.530859 Assignment)
- * (+ 0.825434 Quiz)
- * (- 0.148088 Work sheet)
- * (-2.87500 Assignment * Quiz)
- * (- 1.50000 Assignment
- * Work sheet)
- * (+1.00000 Quiz * Work sheet)
- * (- 1.18520Assignment²)
- * (-1.45036 Quiz²)
- * (- 0.831642 Work sheet²)

Table 2 CCD: Responses for the factors

	F 1	F 2	F 3	R 1	R 2
Run	A:A	B:Q	C:WS	NME	MM
1	2	10	15	18.5	16
2	11	13.0681	8.5	19	17
3	11	-2.0680	8.5	16	14.5
4	20	1	2	22	20
5	11	5.5	8.5	18.5	16
6	-4.1361	5.5	8.5	24	12
7	11	5.5	8.5	30	23.5
8	11	5.5	8.5	20	20

2.2. Numerical methods in Engineering

The Model F-value of 0.64 implies the model is not significant relative to the noise. There is a 74.65% chance that an F-value this large could occur due to noise. P-values less than 0.0500 indicate model terms are significant. In this case there are no significant model terms. Values greater than 0.1000 indicate the model terms are not significant. If there are many insignificant model terms (not counting those required to support hierarchy), model reduction may improve your model.

The Lack of Fit F-value of 1.25 implies the Lack of Fit is not significant relative to the pure error. There is a 40.67% chance that a Lack of Fit F-value this large could occur due to noise. Non-significant lack of fit is good. The equation in terms of actual factors can be used to make predictions about the response for given levels of each factor. Here, the levels should be specified in the original units for each factor. This equation should not be used to determine the relative impact of each factor because the coefficients are scaled to accommodate the units of each factor and the intercept is not at the centre of the design space.

2.3. Mathematical method

The Model F-value of 0.53 implies the model is not significant relative to the noise. There is a 82.43% chance that an F-value this large could occur due to noise. P-values less than 0.0500 indicate model terms are significant. In this case there are no significant model terms. Values greater than 0.1000 indicate the model terms are not significant. If

there are many insignificant model terms (not counting those required to support hierarchy), model reduction may improve your model.

The Lack of Fit F-value of 1.91 implies the Lack of Fit is not significant relative to the pure error. There is a 24.68% chance that a Lack of Fit F-value this large could occur due to noise. Non-significant lack of fit is good.

2.4. Model Validation

Fig. 1 and 2 shows the 3D graphs of the effect of Assignment and Quiz on the final test scores of the two courses. It has little curvilinear shape in accordance to the model fitted.

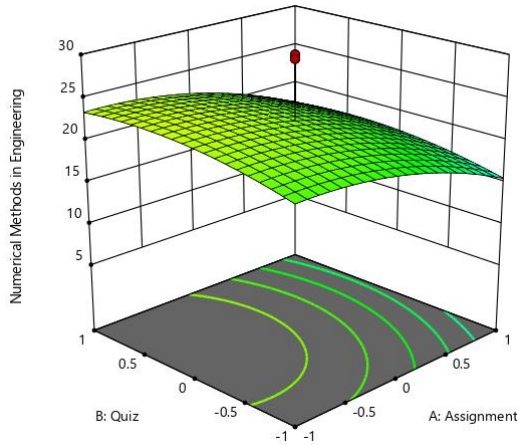

Fig 1. 3D plot for the response 1

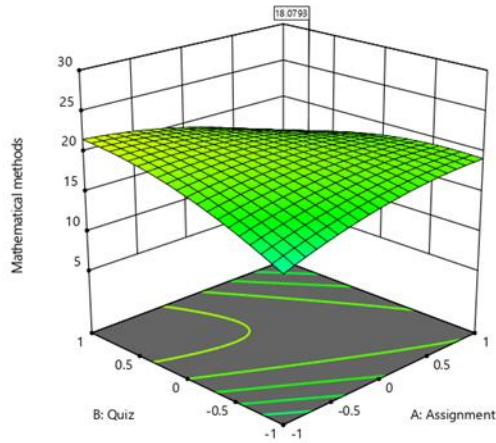

Fig 2. 3D plot for the response 2

The normal probability plots of the residuals for Numerical methods in Engineering and Mathematical methods courses are shown in Fig 3 and 4, respectively. The normal probability plot indicates whether the residuals follow a normal distribution, in which case the points will

follow a straight line. Data points should be approximately linear. A non-linear pattern indicates that there is non-normality in the error term, which may be corrected by a transformation. There are no signs of any problems in this data, thus implying that the errors are distributed normally.

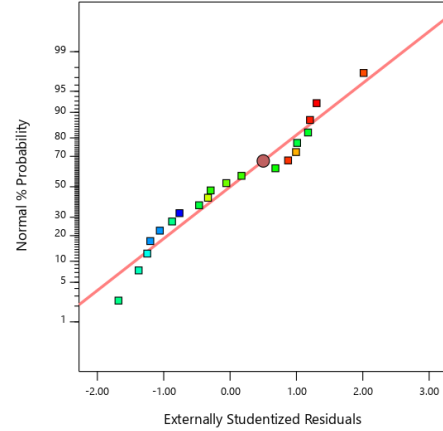

Fig 3. Normal probability plot of residuals for Numerical methods in Engineering results

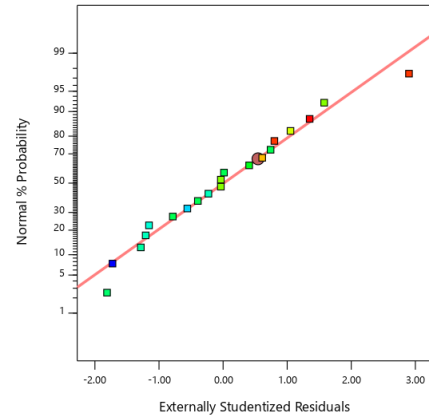

Fig 4. Normal probability plot of residuals for Mathematical methods results

Model summary is given in Table 5, which suggests the model to be evaluated.

Table 5 Model summary

Source	Std dev.	R ²	Adjusted R ²	Predicted R ²	
Linear	6.26	0.0939	-0.0760	-0.4030	
2FI	5.71	0.3880	0.1056	-0.4463	Suggested
Quadratic	5.50	0.5623	0.1684	-0.7203	

Cubic	5.53	0.7353	0.1619	0.1551	Aliased
Linear	6.26	0.0939	-0.0760	-0.4030	

3.0 Results

The results also have important implications for how future accommodation research should be structured to determine the evaluation. The purpose of this paper is to practically demonstrate a method of assessing comparability among two subject final grades. The breadth of the study is fairly limited since only two different mathematical courses are considered. Results ascertained the optimized student assessment using response surface methodology. A non-linear regression equation is developed and projected. The proposed model for this study was found not significant having Fischer test value of 0.6351 and P value of 0.7465. The coefficient of determination R² showed the appropriateness of the adequate model. R² values also determined the trail parameters, their interaction and showed unpredictability in the response. In this study coefficient determination R² = 0.5623 or 50.23% indicated that about 49.77% variations were not determined by the model. The adjusted determination coefficient R² = 0.1684 also showed that the model was not significant. In this model, maximizing the Adjusted R² and the Predicted R² to be focused.

REFERENCES

[1] Betz NE (1978) Prevalence, Distribution and Correlates of Math Anxiety in College Students. *J of Counselling Psychology*, 25 (5): 441-448

[2] National Research Council (1989) *Everybody Counts: A Report to The Nation on The Future of Mathematics Education*, National Academy Press, Washington, DC

[3] Tobias S (1978) *Overcoming Math Anxiety*, New York. W.W. Norton Company, Inc.

[4] Montgomery DC (1997) *Design and Analysis of Experiments*, 4th ed. Wiley, New York

[5] Berberoğlu G (2007) *Türk Bakış Açısından PISA Araştırma Sonuçları*, Konrad Adanouer Stiftung Vakfi. <http://www.konrad.org.tr/Egitimturk/07girayberberoglu.pdf>

[6] Semerci B (2007) *Sınav Stresi ve Başa Çıkma Yolları*, Merkez Kitapçılık, İstanbul

[7] Bianchi F, Stobbe K, Eva K (2008) Comparing academic performance of medical students in distributed learning sites. *The McMaster experience. Medical Teacher* (30), 67-71

[8] Myers RH, Montgomery DC (1995) *Response Surface Methodology*. John Wiley & Sons, New York.

[9] Irizarry M, J R Wilson, J Trevino (2001) A flexible simulation tool for manufacturing cell design II: Response surface analysis and case study. *IIE Transactions* (33): 837 – 846.

[10] Ben-Gal I, J. Bukchin (2002) The ergonomic design of working environment via rapid prototyping tools and design of experiments. *IIE Transactions* 34(4): 375 – 391.

[11] Fu M C (2002) Optimization for simulation: theory vs. practice. *INFORMS Journal on Computing* 14 (3): 192 -215

[12] Tekin E, I Sabuncuoglu (2004) Simulation Optimization: a comprehensive review on theory and applications. *IIE Transactions* (36): 1067 – 1081.

[13] Kleijnen J P C (2009) Kriging metamodeling in simulation: a review. *Eur. J Oper. Res.* (192): 707–716.

TABLE 3 ANOVA for Quadratic model: Response 1: Numerical Methods in Engineering

Source	Sum of Squares	df	Mean Square	F-value	p-value	
Model	251.74	9	27.97	0.6351	0.7465	not significant
A-Assignment	111.89	1	111.89	2.54	0.1420	
B-Quiz	14.31	1	14.31	0.3248	0.5813	
C-Worksheet	6.14	1	6.14	0.1395	0.7166	
AB	0.0313	1	0.0313	0.0007	0.9793	
AC	52.53	1	52.53	1.19	0.3004	
BC	7.03	1	7.03	0.1597	0.6979	
A ²	41.65	1	41.65	0.9457	0.3537	
B ²	22.81	1	22.81	0.5179	0.4882	
C ²	0.0061	1	0.0061	0.0001	0.9908	
Residual	440.39	10	44.04			
Lack of Fit	244.56	5	48.91	1.25	0.4067	not significant
Pure Error	195.83	5	39.17			

TABLE 4 ANOVA for Quadratic model: Response 2: Mathematical Methods

Source	Sum of Squares	df	Mean Square	F-value	p-value	
Model	156.84	9	17.43	0.5284	0.8243	not significant
A-Assignment	3.85	1	3.85	0.1167	0.7397	
B-Quiz	9.30	1	9.30	0.2821	0.6069	
C-Worksheet	0.2995	1	0.2995	0.0091	0.9260	
AB	66.13	1	66.13	2.01	0.1872	
AC	18.00	1	18.00	0.5458	0.4770	
BC	8.00	1	8.00	0.2426	0.6330	
A ²	20.24	1	20.24	0.6138	0.4515	
B ²	30.31	1	30.31	0.9192	0.3603	
C ²	9.97	1	9.97	0.3022	0.5946	
Residual	329.80	10	32.98			
Lack of Fit	216.59	5	43.32	1.91	0.2468	not significant
Pure Error	113.21	5	22.64			
Cor Total	486.64	19				

Numerical Modeling of Flow over an Ogee Crested Spillway under Radial Gate: VOF and MMF Model

^[1] Date V, ^[2] Dey T, ^[3] Joshi S

^[1] Department of Mechanical Engineering, ^[2] Water Resource Department

Abstract- The present research work shows the simulation of the gated flow over an ogee crested spillway for one of water reservoir. The average velocities and Froude Number analysis at various gate openings gives a better insight of flow behavior. Also, the simulations were carried out by changing the gate bottom shape. The STAR CCM+ CFD tool is used to solve the fluid flow performance. The flow parameters near the bottom of the gate have been studied with two types of fluid flow models i.e. Volume of Fluid (VOF) and Multi-Mixture Fluid Models. The use of Volume of Fluid (VOF) multiphase model together with RNG k- ϵ turbulence for the simulation, gives the excellent agreement between the experimental and numerical data. The spillway performance of the gated flow at various gate openings resembles with the actual flow behavior. The applicability of the CFD model to simulate the gated flow over ogee crested spillway is reviewed. The computational model study showed that CFD can be useful in hydraulics structures for designing of various reservoirs. This numerical model gives significant advantage in practice, in terms of parametric studies.

Index Terms— Ogee; Star CCM+; Volume of fluid (VOF); Spillway; Multi-mixture fluid (MMF).

I. INTRODUCTION

Due to recent advances in computing technologies, numerical modeling of hydraulic structures is becoming increasingly important in the engineering field, to the point where these models frequently replace the former industry standard of scaled physical modeling. This replacement is due to certain advantages that are associated with numerical modeling. Numerical models are often much less expensive than physical models because they require no laboratory space, no materials or construction and can be easily modified to accommodate design changes. All that is required for simulations is the computer, the software and the engineering know-how to interpret the results. Although many numerical models exist, validation data is often difficult to obtain and therefore, there is always a level of uncertainty associated with results.

Information regarding the flow of water over spillways has historically been obtained through the use of physical model experiments. Hydraulics experts are interested in CFD and are eager to verify the capability of the numerical modelling software.

Femando [1] gives only real-time predictions of the discharge in any situation of energy head and gate opening within the operation range of reservoir. Riyadh [2] uses CFD tool for validating the experimental analysis with numerical model for flow velocity and pressure. The study of flow rate, water surfaces and crest pressure was carried out by

Kim [3] with FLOW-3D CFD tool and concludes the acceptable numerical errors. Chanel and Doering [4] represent the comparison between gated and free opening flows with FLOW-3D and concluded that CFD should not be considered a complete replacement for physical modelling. Dan Gessler [5] overcomes this issue and proposes that FLOW-3D can be used to simulate the flow over spillway. Jean Chatila [6] used the k- ϵ turbulent model and predicted the reasonable results that are consistent with general flow characteristics over spillway. Fatema [7] simulate flow over an ogee spillway by a commercial numerical model and investigate the ability of the model predict several characteristics of flow. The numerical modelling shows efficiency in studies due to saving in time and money and ability of monitoring all necessary data in several conditions. Bruce M. Savage [8] studied the physical model, numerical model and existing literature. Discharge and pressure data were recorded for 10 different flow conditions which gives reasonably good agreement between physical and numerical models for both pressures and discharges (Figure 1).

Robert [9] did the study on hydraulic model for evaluating flow conditions contributing to abrasion damage in the stilling basin. This study recommended that the spillway gates be operated uniformly for reducing abrasion. James Higgs [10] studied vortices using CFD model and stated that identical flows through each bay will reduce the strength of vortices. Bhajantri [11] evaluated flow over a spillway using two-dimensional finite volume based numerical model which gives satisfactory results between numerical modeling and physical modeling. Also Ho [12] used the CFD

technique for modeling spillway which shows good agreement between published data. Here further investigation will be carried on influence of turbulence flow, non-

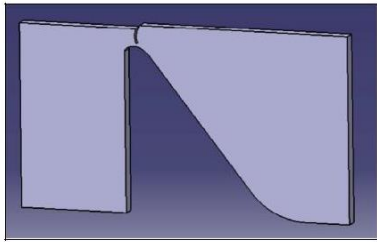

Figure 1: CAD model of fluid domain.

uniform upstream flow and adjacent pier structures. The study carried out by Sadegh [13] showed that optimal design of the guide wall leads to increase the performance of the spillway to pass the flow smoothly. Sebastian [14] studied pressure and velocity at the crest of the spillway and validated the data with experimental data (Figure 2).

NUMERICAL MODELING

Model setup for computational domain can be separated into three main subcomponents as geometry definition, grid definition and boundary conditions. Also it is necessary to define the overall model physics related to the fluid properties. In the numerical modeling



Figure 2: Surface meshing of fluid domain.

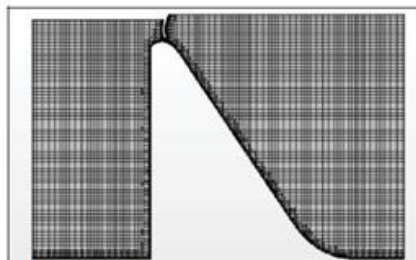

Figure 3: Volume mesh of fluid domain.

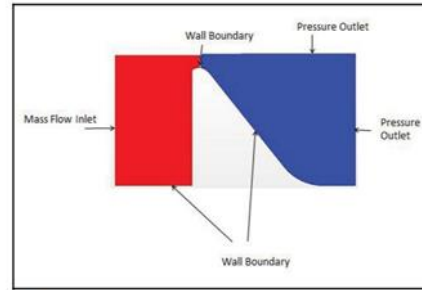

Figure 4: Boundary conditions for simulation model.

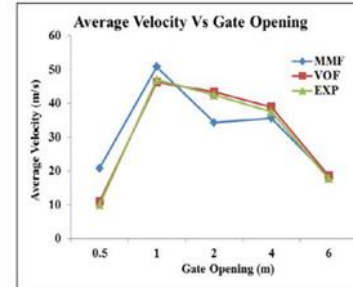

Figure 5: Average velocity variation at different gate openings.

three steps that are necessary to define: geometry definition, grid generation and boundary condition. The geometry definition of the model has many similarities with physical model. The software used for creation of geometry is Computer Aided Three-dimensional Interactive Application (CATIA) V5 R15 due to its simplicity and convenience in part designing, surfacing, wireframe designing, assembly, etc.

Definition of the grid is a significant aspect of the model development. An area with rapidly varying geometry, such as the wing of walls of the spillway, requires small computational cells for accurate resolution. Surface triangles are created on the “CFD ready CAD” surfaces for all configurations with the help of inbuilt meshing of STAR CCM+ software package (Figure 3).

Flow variations are important near gate surface and near the wall of dam. Thus, in order to capture the flow physics at such locations more precisely, mesh refinement is done. The total number of shell elements or surface triangles is approximately 117544.

A 3-D volume mesh was generated using STAR CCM+ after importing the fluid volume in the solver. A 3-D volume mesh consisting of block-structured meshing like cubical blocks placed side-by-side. In the STAR CCM+ CFD software package the block-structured grid is named as

Trimmer and we are using this mesh for the volume meshing in the simulation.

The boundary conditions for solving the problem were defined as shown in Figure 4. The left side of the domain was set as mass flow inlet in this software. Ogee spillway construction and the lower part of the domain were set as the wall boundary conditions. Both the air boundaries at right hand side of the domain were set to pressure outlets. The pressure outlets were initially assumed to be at an atmospheric. The boundaries near the radial gate i.e. gate boundaries were set to the wall boundary as the gate was fixed at some opening. Wall boundary conditions in this problem were all set to the stationary, no-slip wall. Fluid Flow Modeling

VOLUME OF FLUID (VOF) MODEL

The volume of fluid model is based on the fact that two phases of flow problem i.e. air and water was not to be interpenetrating them. Here the sum of volume fractions in each cell was unity. As the different volume cells of the domain were shared by either the phases or single phase. Therefore different variables and properties of each volume cell is the function of volume fraction of one of the phases or combination of both the phases, depending on the values of volume fraction. The different values of properties and variables at each cell were calculated from the advection of the fluid at each cell face.

For solving the fluid domain, a RNG k- ϵ momentum equation was solved throughout the domain. In which the value of different variables and properties were calculated at each cell face. The resulting velocity field was distributed among all the phases in the domain. The momentum equation given below is depends on the volume fractions of all phases through the properties ρ and μ .

$$\frac{\partial}{\partial t}(\delta \bar{u}) + \nabla(\delta \bar{u} \bar{u}) = -\nabla p + \left[\mu (\nabla \bar{u}^T) \right] \rho \bar{g} + \bar{F} \quad (1)$$

MULTI-MIXTURE FLOW (MMF) MODEL

The MMF model is suggested to use for bubbly flows and pneumatic transport. It is a simplified multiphase model that can be used where the phases move at different velocities, but assume local equilibrium over short spatial length scales. The coupling between the phases should be strong. It can also be used to model homogeneous multiphase flows with very strong coupling and the phases moving at the same velocity. The mixture model can model n phases by the continuity equation for the mixture, the momentum equation

for the mixture, and the volume fraction equation for the secondary phases, as well as algebraic expressions for the relative velocities.

Continuity equation:

$$\frac{\partial}{\partial t}(\rho_m) + \nabla(\rho_m \bar{u}_m) = 0 \quad (2)$$

Momentum equation:

$$\frac{\partial}{\partial t}(\rho_m \bar{u}_m) + \nabla(\rho_m \bar{u}_m \bar{u}_m) = -\nabla p + \nabla \left[\mu_m (\nabla \bar{u}_m + \bar{u}_m^T) \right] + \left[\sum_{k=1}^n \alpha_k \rho_k \bar{u}_{dr,k} \bar{u}_{dr,k} \right] \quad (3)$$

It is a relatively recent development from the standard k-model is RNG k-model. The RNG turbulence model solves for turbulent kinetic energy (k) and turbulent kinetic energy dissipation rate (ϵ). The RNG-based models rely less on empirical constants while setting a framework for the derivation of a range of parameters to be used at different turbulence scales.

RESULTS AND ANALYSIS

Validation of the average velocity variation

The experimental data of the velocities at various gate openings is validated against the VOF model and MMF model in which VOF model gives the close agreement as compared to the MMF model. Figure

Gate Opening (m)	Average Velocity (m/s)			Difference (%)	
	Experiment al	VOF	MMF	VOF	MMF
0.5	10	10.955	20.799	8.7	107.99
1	47	46.28878	50.789	1.5	8.06
2	42.5	43.36421	34.307	2	19.27
4	37.5	38.93685	35.628	3.7	4.99
6	17.7	18.5856	18.478	4.8	4.39

Table 1: Average velocity comparison near gate bottom of gated spillway flow.

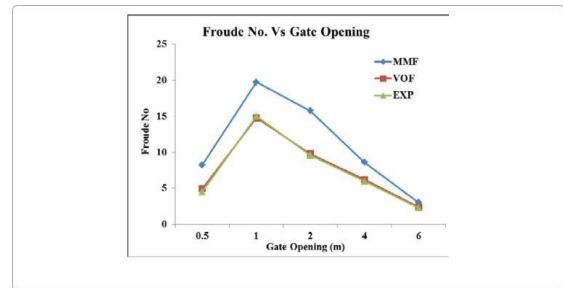

Figure 6: Froude number variation at different gate openings.

Gate Opening	Froude Number (F_r)	Difference (%)
--------------	-------------------------	----------------

(m)	Experimental	VOF	MMF	VOF	MMF
0.5	4.52	4.946	5.2510	9.55	16.29
1	15	14.779	16.743	1.51	11.57
2	9.6	9.79	11.759	2.03	22.55
4	6	6.22	7.5969	3.83	26.90
6	2.31	2.423	3.0233	5.0	31.04

Table 2: Froude Number (Fr) comparison near gate bottom of gated spillway flow.

5 showed a comparison of the experimental data and the numerical model as described in the Table 1.

As seen in Figure 5 there is excellent agreement between the predicted and measured average velocities for the VOF model which were never exceeding more than 9%. The difference observed between these predicted and numerical model were due to the approximations made in the simulation model and also due to small errors in the water level at gate openings, caused by the spill region at inlet boundary. The MMF model shows the large percentage of errors so we preferred VOF model for the simulations (Figure 6).

Validation of the froude number (Fr) variation

The Froude number (Fr) variation near the gate bottom is found to be supercritical for all gate openings. The Froude number (Fr) analysis was carried out by both the fluid flow modeling's i.e. by VOF model and MMF model. The results obtained showed that the difference between the experimental data and the VOF model shows better agreement than the MMF model. From Table 2 it is shown that difference between VOF and experimental lies below 9% and that of between MMF and experimental lies above the 9% for this spillway problem. Hence the VOF model should be suitable for the fluid flow modeling rather than MMF Model.

Also Froude number (Fr) for the higher gate openings are lesser than the small gate openings. It shows that the flow is more supercritical at small gate openings than that of higher gate openings. The flow tends to critical region as we go on increasing the gate openings. Hence gates should be operated at higher gate openings.

CONCLUSION

A numerical model using VOF multiphase flow model together with RNG k- ϵ turbulence model is more suitable than MMF model to simulate the flow over an ogee crested spillway with gated flow. The data obtained from large scale experiments of dam reservoir verifies the VOF model data more significantly.

The Froude Number variation after 1m gate opening approaches towards unity i.e. flow tends to be critical. So we must not keep the open at 1m opening for long time as the flow is more supercritical in this region it should be operated at 6 m or full gate opening for dam reservoir.

The above study showed that CFD can be viewed as better design tool for hydraulic structures with proper analysis for validation. Number of cases could be easily simulated which provide us the information about the various flow parameters such as velocity, flow, pressure, and another parameter associated with dam flow. Finally, the numerical model has many advantages in practice, in terms of parametric study.

REFERENCES

1. Salazar F, Morán R, Rossi R, Oñate E (2013) Analysis of the discharge capacity of radial-gated spillways using CFD and ANN –oliana dam case study. J Hydraulic Res 1: 1-9.
2. Al-Zubaidy RZ, Muttaleb AS, Alhashimi H (2013) Numerical simulation of two-phase flow over mandali dam ogee spillway. Int J Structural and Civil Eng Res 2: 1-13.
3. Kim DG, Park JH (2005) Analysis of flow structure over ogee-spillway in consideration of scale and roughness effects by using CFD model. KSCE J Civil Eng 9: 161.
4. Chanel PG, Doering JC (2008) Assessment of spillway modeling using computational fluid dynamics. Canadian J Civil Eng 35: 1481-1485.
5. Gessler D (2005) CFD modeling of spillway performance. J Impact of global climate change pp. 1-10.
6. Chatila J, Tabbara M (2004) Computational modeling of flow over an ogee spillway. J Computers and Structures 82: 1805-1812.
7. Goharrizi FZ, Moghadam MA (2010) Evaluation of a numerical modeling for flow over an ogee spillway. 8th International River Engineering Conference Shahid Chamran University pp. 110-116.
8. Savage BM, Johnson MC (2001) Flow over ogee spillway: Physical and numerical model study. J of Hydraulic Eng 127: 640-649.

9. Einhellig RF (1999) Hydraulic model study of folsom dam spillway performance and stilling basin abrasion. US Department of the Interior Bureau of Reclamation pp. 125-131.
10. Higgs JA (1997) Folsom dam spillway vortices computational fluid dynamic model study. US Department of the Interior Bureau of Reclamation pp. 31-37.
11. Bhajantri MR, Eldhoand TI, Deolalikar PB (2006) Hydrodynamic modelling of flow over a spillway using a two-dimensional finite volume-based numerical model. *Sadhana* 31: 743-754.
12. Ho DKH, Boyes KM, Donohoo SM (2001) Investigation of spillway behavior under increased maximum flood by computational fluid dynamics technique. 14th Australasian Fluid Mechanics Conference Adelaide University pp.10-14.
13. Dehdar-behbahani S, Parsaie A (2016) Numerical modeling of flow pattern in dam spillway's guide wall. Case study: Balaroud dam, Iran. *Alexandria Eng J* 55: 467-473.
14. Erpicum S, Peltier Y, Dewals B, Archambeau P, Pirotton M (2017) Pressure and velocity on an ogee spillway crest operating at high head ratio: Experimental measurements and validation. *J Hydro-environment Res* pp. 1-9.

Commentary on Aeronautics and Aerospace Engineering

^[1] Lamar JE

^[1] BS in Aerospace Engineering, University of Alabama, NASA Langley Research Center, Virginia, USA

I have two aeronautical questions for which I would like to have information. I do hope that these questions may have already been answered by those currently working in the fields of flight-testing and aeronautics but, just in case they have not, they are as follows:

Which is the most accurate and tested manner of using pressure-belts for obtaining flight-pressure measurements on aircraft that have significant leading-edge vertical flows?

My colleagues and I have obtained useful results with pressure-belts oriented both perpendicular to the leading-edge on a 60 degree delta-wing aircraft (F-106B-reported in NASA TP-3374) as well as stream wise on a cropped arrow aircraft (F-16XL-1-reported in NASA/TP-2001-210629). Stream wise is best for integrating the pressure data at specific butt lines, plus the ports can be staggered along these belts so that data can be plotted /integrated at constant fuselage-stations. But for wings with significant vertical flows, I have not seen the answer to the pressure-accuracy question. (I am familiar with the paper by Poisson-Quinton, Philippe. Eight Theodore von Karman Memorial lecture: Slender Wings for Civil and Military Aircraft. Israel Journal of Technology 1978;16(3):97-131 in which Concorde flight- and wind-tunnel-pressures compare very well, but I do not know the details of how the flight-pressure data was obtained.)

The question goes away if one can use holes in the structure for the pressure-measurements, but that is not always possible in aircraft-due to its wet wing-as it is for a wind-tunnel model. I know that for sharp-edged delta-wing wind-tunnel models, a preferred placement of these holes is along rays, emanating from the apex, that correspond to fixed longitudinal-locations; this enables one to look for stream wise changes in the vortex structure and the onset of the trailing-edge influence.

Why is there a difference in commercial jet-transport wing-tip designs?

I am familiar with the work of Dr. Richard Whitcomb of NASA Langley Research Center in terms of his upper- and lower-winglets to increase the aerodynamic-thrust at the wing-tips during transonic speeds, as I was a NASA reviewer of the paper. Through careful tailoring of the winglets, his solution could also be used to reduce the wing-root bending moment.

Some commercial aircraft use mostly a full-chord upper-winglet while others have a basic triangle at the tip extending both above and below the wing. I am sure there are analytical and experimentally-verified reasons why there should be these two different solutions for this problem and would be interested in the answer. I do understand that some of the rationale may be company sensitive.

Unconventional Gas Production from Hydraulically Fractured Well - A Application of Direct Search Based Optimization Algorithm

^[1] M.M. Rahman, ^[2] A. Suboyin, ^[3] M. Haroun
^{[1][2][3]} Khalifa University of Science and Technology, Abu Dhabi, UAE

Abstract- Unconventional gas reservoirs are now the targets for meeting the demand for gas. These reservoirs are at the depth of more than 10,000 ft (even over 15000 depth as well) and are difficult to be exploited by conventional methods. For the last decades hydraulic fracturing has become the tool to develop these resources. Mathematical models (2D and pseudo-3D) have been developed for fracture geometry, which should be realistically created at the depth by surface controllable treatment parameters. If the reservoir rock is sandstone, then proppant fracturing is suitable and if the rock is carbonates, then acid fracturing is applicable. In both cases, proper design of controllable treatment parameters within constraints is essential. This needs proper optimization model which gives real controllable parametric values. The model needs the most important analyses from geomechanical study and linear elastic fracture mechanics of rock containing unconventional gas so that fracture geometry makes maximum contact with the reservoirs for maximum recovery. Currently available software may lack proper optimization scheme containing geomechanical stress model, fracture geometry, natural fracture interactions, real field constraints and proper reservoir engineering model of unconventional gas resources, that is, production model from hydraulically fractured well (vertical and horizontal).

An optimization algorithm has been developed to integrate all the modules, as mentioned above, controllable parameters, field constraints and production model with an objective function of maximum production (with or without minimization of treatment cost). Optimization is basically developed based on Direct Search Genetic and Polytope algorithm, which can handle dual objective function, non-differentiable equations, discontinuity and non-linearity. A dual objective function will help satisfy operator's economic constraints and also to investigate conflict between two measures of merit. The integrated model can be applied to a vertical or horizontal well in tight gas or ultra-tight shale gas deeper than over 10,000 ft. A simulation (with industrial simulators) was conducted to investigate fracture propagation behavior in tight gas reservoirs under varying parameters with respect to the fracture design process. Results indicate that hydraulic fracture propagation behavior is not uninhibited in deep reservoirs as some may believe that minor variations of variables such as in-situ stress, fluid properties etc. are often detrimental to fracture propagation in some conditions. Application of this model to a hypothetical tight and ultra-tight unconventional gas formations indicates a significant gas production at lower treatment cost; whereas the resources do not flow without any stimulation (hydraulic fracturing).

I. INTRODUCTION

Over the past few decades, science of geomechanics has been applied to create a fracture hydraulically in a rock formation deeper than 10,000 ft from the surface onshore and offshore to exploit more oil and gas. This has become applied engineering of hydraulic fracturing in the petroleum industry to produce conventional and unconventional hydrocarbon resources. To design this fracture, a certain operational parameters are required, which are functions of geomechanics, hydrocarbon properties and surface operational constraints. Of course, economics and environmental issues are highly important in the industry. The operational parameters are to be designed as a best possible set of values of treatment (design) parameters, such as fracturing fluid viscosity (power law parameters), injection rate & time, proppant concentration, etc, so that a desired fracture geometry is created to achieve the objectives

in a given deeper rock formation [1]. This becomes a complex problem which must be coupled with formation in-situ properties, hydraulic fracture growth through volume balance of injected fracturing fluid, reservoir fluid flow through fractures and investment-return economics. Design must be optimized satisfying all controlled and uncontrolled realistic constraints, so that the operational parameters are executable in the field. Various methods are available in the literature to perform each of these tasks in the overall solution process. The technique of the solution adopted over time is also not unique [1].

Several methods have been developed, but some perform a particular task on a number of assumptions, which apply to a particular formation. Selection of an inappropriate method may cause unnecessary mathematical complexity with no better solution than any arbitrary design. This does not achieve the objectives globally. To systematically deal with such complexities/uncertainties at various levels, the authors presented this work as a hydraulic fracturing design process for unconventional gas resources. An globally appropriate

method to perform a task is selected based on various aspects of the job, the degree of sophistication required in modeling the overall problem and uncertainties involved with all the alternative methods [1]. In selecting a method for a particular node, a bi-directional information exchange with compatible accuracy levels is emphasized between the decision node and its connecting nodes in a system analysis approach. The solution tool is seldom considered as an integral part of the overall hydraulic fracturing design process for exploiting unconventional gas resources [1].

This work selects a mathematical solution technique and then selects one for hydraulic fracture design task assessing its special features. The capability of the solution technique must be reflected in all other decision nodes. That is, solution technique should be able to handle certain features of the overall problem (e.g. non-linearity, discontinuity, non-differentiability), then the overly sophisticated modeling does provide a good design. The overall modeling process is formulated within the framework of the algorithm for optimum solution [1, 2].

Even after stimulation of such formations, the targeted permeability and production is often not achieved in ultra-tight formations. Authors study the complication of flow behavior of hydrocarbons and other fluids in reservoirs due to natural fractures that exist within such reservoirs. This leads to complexities such as premature water breakthroughs, reduced recovery rates, channeling of injected fluids, fracture collapses as conduits due to changes in reservoir pressure [3]. These ultimately lead to higher expenditures along with ultimate recoveries that are lower than expected, particularly development of shale reservoirs is still associated with a high degree of uncertainty and risk. As a significant amount of time, money, material and manpower is involved, it is crucial to optimize the design while achieving the target. Further studies indicate that for an effective, efficient and economical hydraulic fracture treatment design the impact of various in-situ parameters along with the design parameters must be analyzed in depth to better understand the fracture propagation behavior [3, 4, 5, 6].

In this paper authors emphasized the need of optimum and goal-oriented design (with the significance of contributing parameters to the fracture geometry and post-fracture fluid flow) and also discussed the benefits of hydraulic fracturing, without which tight and ultra-tight gas formations cannot be exploited.

DIRECT SEARCH BASED ALGORITHM

The overall hydraulic fracturing design is an integrated model of a system analysis (Figure 1). Optimization

algorithm is a solution tool and a module in the integrated model. This algorithm is genetic and polytope and is described briefly here, which is based direct search method. The central problem of mathematical programming is usually stated as the optimization (in the mathematical sense of maximization or minimization) of a function $f(x_1, x_2, \dots, x_N)$ of several variables x_1, x_2, \dots, x_N subject to a set of constraints [2].

There are voluminous literatures on various optimization methods and their applications to linear and nonlinear problems [7, 8]. Mathematical programming methods are the classical techniques of optimization as applied to nonlinear programming. Most methods were invented by mathematicians based on classical differential calculus, and they inherit the assumptions of continuous differentiability, availability of gradient vectors and existence of second derivatives. For problems with differentiable smooth functions, these derivative based methods are reliable and computationally efficient. Many real-world engineering design problems, however, involve discontinuous and non-differentiable functions, design variables requiring a combination of continuous, integer and discrete values and conflicting multiple design objectives. The difficulty of non-differentiability in using the methods is attempted to overcome by various numerical differentiation techniques with various degrees of accuracy. Attention has been focused to develop alternative algorithms, particularly direct search methods, by manipulating basic mathematics of optimization methods. They are normal-boundary intersection algorithm [9], genetic algorithms (GA) [10], polytope algorithm (PA) [11], and evolutionary operation (EVOP) [12]. Direct search methods, such as GA, PA and EVOP are generally slow in convergence but are successful to find reliable optimum solutions of problems having high degree of various noises including discontinuity and non-differentiability in functions [1, 12].

The objective and constraint functions involved with hydraulic fracturing optimisation are highly non-linear and non-differentiable. These functions are also subjected to a certain number of discontinuities. These include numerically unstable sub-functions, such as the complementary error function, bi-section solution, etc. A direct search based algorithm, combining the major features of genetic algorithm and polytope finds optimum solution by generating and moving an object (called 'compound') using 'intelligence' more than mathematics [12].

General formulations of this algorithm can be expressed as [2, 12]:

Find

$$\underline{x}^T = \{x_1, x_2, \dots, x_i, \dots, x_N\} \quad (1)$$

subject to bound constraints

$$\left. \begin{array}{l} l_1 \leq x_1 \leq u_1 \\ \cdot \quad \cdot \quad \cdot \\ \cdot \quad \cdot \quad \cdot \\ l_N \leq x_N \leq u_N \end{array} \right\} \quad (2)$$

and design constraints

$$\left. \begin{array}{l} C_{l1} \leq C_1(\underline{x}) \leq C_{u1} \\ \cdot \quad \cdot \quad \cdot \\ \cdot \quad \cdot \quad \cdot \\ C_{lM} \leq C_M(\underline{x}) \leq C_{uM} \end{array} \right\} \quad (3)$$

to minimize

$$Z = f(\underline{x}) \quad (4)$$

where, \underline{x} represents the vector of free design variables (the

where, \underline{x} represents the vector of free design variables (the superscript 'T' for transpose); l_i 's and u_i 's are constants or

functions of \underline{x} (in the latter case the bound constraints constitute moving boundaries) representing the ranges of

x_i 's; C_{li} 's and C_{ui} 's are constants or functions of \underline{x} representing the acceptable ranges of design constraints,

$C_i(\underline{x})$'s; N is the total number of free design variables and M is the total number of design constraints. The function $f(\underline{x})$ is to be minimized, which can be single objective or multiple objectives [2, 12].

The optimisation procedure starts with an initial vertex (point, design) in the N -dimensional space bounded by the ranges of design variables, as shown in Figure 4 in a two-dimensional space for the convenience of description. Straight lines (l_1, u_1 and l_2, u_2) parallel to the co-ordinate axes represent the lower and upper bounds on variables, x_1 and x_2 , respectively. Curved lines C_{l1} and C_{u1} represents the lower and upper bounds, respectively, on design constraint 1, $C_1(\underline{x})$, and C_{l2} and C_{u2} on design constraint 2, $C_2(\underline{x})$. Certainly, there could be more than these two design constraints and their lower and upper bounds. The area along the hatched direction is the two-dimensional feasible search space. The initial vertex must be within the variable bounds, and may or may not satisfy the design constraints. If the initial vertex does not satisfy any of the design constraints (i.e. not within the hatched area), a random vertex is generated. If the random vertex is still in the infeasible region, the distance between these two vertices is estimated and the generated vertex is moved stepwise halftimes the distance each time along the straight line with these two vertices until the vertex satisfies all the design constraints. If the positive step-length moves the vertex

away from the unsatisfied design constraint bound(s), a negative step-length is used. The vertex 'a' is either an initial feasible vertex, or a vertex moved from its initial infeasible location. The coordinates of a random vertex are generated by:

$$x_i = l_i + r_i(u_i - l_i); \quad i = 1, \dots, N \quad (5)$$

The pseudo-random deviate r_i rectangularly distributes over the interval (0, 1) and is controlled by the known value, x_{in} for the i -th coordinate of the initial vertex [2, 12].

Executing Eq. 5 $K-1$ times, further $K-1$ different random points are generated, where $K = 2N$ for $N \leq 5$ and $K = N + 1$ for $N > 5$. Eq. 5 itself ensures that the randomly generated points remain in the space bounded by the ranges of variables defined by Eq. 2. However, any of the generated points may initially violate any of the design constraints defined by Eq. 3 and therefore a technique, better than described above, is required to move such points towards satisfying Eq. 3. The four vertices for two-dimensional space ($2N$) a, b', c' and d' are shown (Figure 4). Obviously, vertices b', c' and d' violate Eq. 3. These vertices are modified in the order of d', c' and b' by moving successively towards the centroid, \underline{c} by:

$$\underline{x} = \frac{1}{2}(\underline{c} + \underline{x}') \quad (6)$$

until the new point, \underline{x} satisfies Eq. 3. The coordinates of the centroid, \underline{c} are calculated using vertices that have already satisfied Eq. 3 as follows:

$$c_i = \frac{1}{n} \sum_{i=1}^n x_i \quad (7)$$

where n is the number of vertices which have already satisfied Eq. 3.

The modified points are a, b, c and d which satisfy both Eqs. 2 and 3. These four feasible vertices comprise an object called 'compound' abcd (Figure 2). The values of the objective function, $f(a)$, $f(b)$, $f(c)$ and $f(d)$ at these four vertices are calculated and assumed to be in the order of $f(a) < f(b) < f(c) < f(d)$. If the initial notations of vertices do not satisfy this order, vertices are re-denoted according to this order. In fact, the point that corresponds to the minimum objective function value is preserved and the new random points are generated around this point. The procedure is repeated as long as objective function can be minimized further. In a sense, the same point (object) is moving to a new location in every step, using intelligent information until the minimum objective function is established [12].

For a convex feasible parameter space the above method for moving an infeasible vertex to the feasible space would,

without fail, succeed in generating a compound with K vertices. If the parameter space is nonconvex, and the centroid happens to lie in the infeasible area, there is every chance that a compound cannot be generated. Figure 3 shows such a possibility. Three vertices a, b and c in the feasible parameter space have already been generated. In order to generate the fourth feasible vertex a trial point, T_1 satisfying the variable bounds is created. However, T_1 is infeasible as it violates a design constraint. In order to make T_1 feasible it is continually moved halfway towards the centroid, X . Since the centroid itself is infeasible no amount of such moves would make T_1 feasible, and a compound with four vertices can never be generated. Safeguard against such a possibility is never to allow an infeasible centroid. If a new feasible vertex results in the new centroid to lie in the infeasible area, that new vertex is discarded, and another generated until a feasible centroid is obtained [2, 12].

MECHANICS OF HYDRAULIC FRACTURE

Hydraulic fracture is derived from science of rock mechanics. In petroleum engineering, fracture geometry is defined by length, height and width of a fracture, which are function of fracture treatment parameters. Finally, propped fracture geometry helps reservoir fluid flow towards the wellbore. A 2D model 'PKN-C' is used in this work (Figure 4) because its vertical plane strain assumption is physically more acceptable for the proposed height-contained fracture where the fracture length becomes considerably greater than the fracture height [13, 14, 15]. The model can be used for both Newtonian and non-Newtonian fracturing fluids. For detail of the model's mathematical equations, readers are advised to see the reference of Valko and Economides [5].

A pseudo-3D model for multi-layered formations is also proposed, derived originally from 2D model. The 3D models are called 'pseudo', because they do not consider the variation of fracture geometry in a three-dimensional space, rather it modifies the 2D (PKN-C) model by adding height variation along the fracture length and its effect on the fracture width. The height variation along the fracture length can be considered linear or parabolic. The equilibrium height of a hydraulic fracture for a given internal pressure in a layered-stress environment can be calculated if material property variations in each stress layer are neglected and vertical pressure distribution in the fracture is assumed constant. The stress-intensity factors are calculated at the top and bottom tips of the fracture and set equal to the fracture toughnesses of the materials, resulting in a unique height and position, or centering of the crack with respect to the stress field [16]. Figure 5 shows the schematic of P-3D fracture geometry. Readers are advised to see the reference of Warpinski and Smith [16] for details of mathematics.

Fluid Flow from Hydraulically Fractured Well

For unconventional formations, particularly moderate and tight formations, several models are developed; but for ultra-tight (with nano-Darcy) formation, model is not well defined because Darcy equation is not enough to model the gas flow. There is tri-linear fluid flow model developed for transversely fractured horizontal well, however, this needs to be further refined [17] for a hydraulically fractured horizontal well; however, it is not suitable for nano-Darcy formations. For ultra-tight and unconventional gas resources a fluid flow model based on compartmentalized reservoir engineering is desirable and is still under development. In fact, this is a complex inter-relationships between matrix, natural fracture, propped hydraulic fracture, wellbore and fluid and geomechanical properties, a predictive model needs to be developed or being developed in the industry with all realistic constraints. A few software are being used to estimate the gas production from unconventional resources fractured hydraulically. For details of mathematical model, readers are advised to read the literatures [18, 19, 20].

Treatment Parameters and Design Requirements

There are free design variables, which are called hydraulic fracturing treatment parameters. They are injection rate, injection time, fracturing fluid viscosity (with power law parameters) and proppant concentration and are directly or indirectly related to fracture geometry and gas flow from fractured well. Fracture half-length, height and width are calculated as function of these variables by solving the coupled-material balance relationship. Each free design variable has an upper bound and a lower bound value, based on field practices (Table 1). Some important design requirements are presented in brief [1]:

1. $1.0 \leq C_1(\underline{x}) \leq 10.0$: where $C_1(\underline{x})$ ensures that pump's available horsepower should be more than the horsepower required for the job as high hydraulic power is required for injection.
2. $1.0 \leq C_3(\underline{x}) \leq 15$: where $C_3(\underline{x})$ ensures that design pressure rating of all surface and downhole equipment are more than the pressure developed during the injection.
3. $1.0 \leq C_4(\underline{x}) \leq 10.0$: where $C_4(\underline{x})$ means the limitation of fracture height to migrate to bounding layers, avoiding interacting any undesirable formations.
4. $1.0 \leq C_6(\underline{x}) \leq 5.0$: where $C_6(\underline{x})$ ensures that the average dynamic fracture width is at least four times the proppant diameter, providing proppant transportation to the fracture end as much as possible.
5. $1.0 \leq C_8(\underline{x}) \leq 10.0$: where $C_8(\underline{x})$ means that the formation critical pressure must be greater than the

fracture treatment pressure for proper fracture growth with containment.

6. $1.0 \leq C_9(\underline{x}) \leq 10.0$: where $C_9(\underline{x})$ ensures that net fracture pressure does not exceed the difference between the minimum horizontal stresses in the pay zone and the bounding layers to contain the fracture.

DESIGN OBJECTIVE

Any optimization algorithm needs an objective function. Algorithm can demonstrate its capability to generate a compromised design by resolving conflicts when there are two measures of merit. The general form of the objective function is [2, 12]:

$$\text{minimize } Z = \sum_{i=1}^I \frac{(f_i(\underline{x}) - T_i)}{D_i} P_i \quad (8)$$

where $f_i(\underline{x})$ is the objective function for i -th objective; T_i is the target value for the i -th objective; D_i is the dividing factor for i -th objective equation and P_i is the priority to achieve the i -th objective (if there is a requirement). I is the total number of measures of merit to be considered in the design. This algorithm can handle combined objective functions.

- Maximize total gas production (G_p) over a number of years.

$$\text{minimize } Z = \text{minimize } (-G_p)$$

- Maximize net present value (NPV) over a number of years.

$$\text{minimize } Z = \text{minimize } (-NPV)$$

APPLICATION TO UNCONVENTIONAL GAS RESOURCES

All the modules in Figure 1 are defined with data, mathematics and logics, where applicable. They all are linked to the optimization algorithm. Design requirements, fracture geometry, gas production and economics are defined mathematically and are also linked to objective function. Table 2 shows the data for tight gas formation.

Table 3 shows the data for ultra-tight shale gas formation (to be stimulated by transversely fractured horizontal well,

Figure 7). Transversely fractured horizontal well in ultra-tight shale gas formation is considered to be stimulated here. For optimum design, in addition to this integrated model, simulators (provided by Schlumberger) has been utilized. These simulators are apt in modeling of reservoirs that produces relatively dry gas, with minimal interference from other liquids such as oil or water with their own set of advantages and disadvantages. A discrete natural fracture network (DFN) is incorporated in the geometry. Properties of discrete features are also the component controlling flow and transport. DFN can lead to a more realistic description of the network as they are stochastic models that incorporate statistical scaling rules derived from analysis of fracture length, height, spacing, orientation, and aperture [21].

RESULTS AND DISCUSSIONS

Three arbitrarily different designs are applied to the model as initial design to run the program to achieve the maximum NPV from a hydraulically fractured vertical well in tight gas formation (Table 2). The optimization model achieved the final optimum design by executing a number of redesign iterations for each initial design. Three optimum designs, starting with three initial designs, were very slightly different values within the convergence tolerance. One of the initial designs and the optimum design are presented in Table 4 [1]. Initial designs have been improved significantly by optimization (by maximum 44% NPV), which is the benefit of using the optimization model in hydraulic fracturing treatment design. This optimization tool will greatly enhance the capability of a designer to achieve the best possible design satisfying all complex design constraints.

The program was run for both objectives (Design 1: maximization of total gas production and Design 2: maximization of net present value) for about 10 years production. The program was also run for the third objective (Design 3: maximizing NPV and minimizing treatment cost, Ctr). Results of three design objectives are presented in Table 4. The maximum NPV design (Design 2) is very close to the maximum production design (Design 1). In Design 3, optimum design is different and a significant percentage of 45% of treatment cost savings (over 10 years) have been achieved over Design 1 and Design 2. However, this saving is as a result of 11% NPV reduction over 10 years. This is a compromised design, as handled by this optimization algorithm, by adjusting priority factors to individual measures of merit. Though this objective is not so important to the petroleum industry, authors did this work to present the capability of this algorithm. The gas production model was run for the same well with no hydraulic fracture. It is

evident that there was significant incremental production of gas (by about 300%) compared to non-fractured well (Figure 6). Predicted cumulative gas production from non-fractured vertical well over ten years is 6 BSCF and the same for the fractured well is 26 BSCF for 640 acres reservoir.

With regard to ultra-tight shale gas stimulation, different stages are involved using the simulators (not detailed here). After building and validating the models using industrial static simulators, a simplistic model was constructed to study the benefit of hydraulic fracturing. As shown in Figure 7, the simplistic model integrates a horizontal well with 10 induced hydraulic fractures and 2 sets of natural fractures in a shale gas reservoir. The interaction, the pressure response and the cumulative gas produced with respect to changes in fracture properties are investigated. The study is extended by building a realistic model based on Marcellus Shale data along with field parameters as shown in Figure 8. Based on 10 transverse fractures (ten stages) in this horizontal well, shale gas production rate and cumulative production are presented for ten years (Figure 9) from 120 acres reservoir. This is the predicted benefit of hydraulic fracturing. Without fracturing, there is no gas flow because of ultra-tight shale formation (nano-Darcy permeability formation). So, hydraulic fracturing is a must for exploiting unconventional gas resources.

CONCLUSIONS

Based on this study, the following conclusions are made:

- The proposed optimization model with direct search based Genetic & Polytope algorithm can deal with non-linearity, non-differentiability and discontinuity and optimize hydraulic fracture treatment design parameters, satisfying all design constraints. Algorithm can handle two measures of merit.
- Maximum gas production can be achieved from tight and ultra-tight formations by implementing this optimum design, which is executable in the field. Optimum design is better any arbitrary design, even it is executable. Predicted gas production is much higher compared to a non-fractured well.
- Based on a comprehensive simulation study (using industrial simulators) on ultra-tight shale gas formation, a set of transverse fractures can be designed for a horizontal well and gas production can be predicted if optimum design is properly executed in the field. It is evident that there is no gas flow through the unconventional shale gas formation without hydraulic fracturing. With fracturing, there is significant gas production predicted for ten years (5 BSCF) compared to no-flow from non-fractured well.

- With this simulation and modeling, investigation of hydraulic fracture propagation behavior in the presence of natural fractures in shale gas reservoirs can be conducted and effect of treatment design parameters on gas production can also be conducted using a sensitivity analysis (not presented here).

ACKNOWLEDGMENT

The authors would like to recognize and express their sincerest gratitude to the Khalifa University of Science and Technology for providing opportunities in conducting this study. The authors would also like to extend their thanks to National Energy Technology Laboratory and Schlumberger, for their software donation to Khalifa University and for graciously allowing to utilize their software for this investigation.

REFERENCES

- [1] M.M. Rahman, "Hydraulic Fracture Optimization Model with Intelligent Moving Object Algorithm to Maximize Gas production in Petroleum Industry", An International Conference on Engineering and Applied Sciences Optimization, OPT-I, Kos Island, Greece, 4-6 June, 2014.
- [2] B.D. Bunday. Basic Optimization Methods. Edward Arnold Ltd., London, 1984.
- [3] J. N. Ogbechie, "Fracture Modeling and Flow Behavior in Shale Gas Reservoirs Using Discrete Fracture Networks", MSc Thesis, Texas A&M University, 2011.
- [4] A. L. Khlaifat, H. Qutob, N. Barakat, "Tight Gas Sands Development Is Critical To Future World Energy Resources", SPE-142049 Middle East Unconventional Gas Conference and Exhibition, Muscat, Oman, 2011.
- [5] P. Valko, M.J. Economides, "Hydraulic Fracture Mechanics", John Wiley and Sons, Chichester, England, 1995.
- [6] M.M. Rahman, M.K. Rahman, S.S. Rahman, "Optimizing Treatment Parameters for Enhanced Hydrocarbon Production by Hydraulic Fracturing", Journal of Canadian Petroleum Technology, vol. 32 (6), pp. 38-46, 2003.
- [7] B.T. Polyak, "Introduction to Optimization", Optimization Software Inc., New York, 1987.
- [8] J.P. Ignizio, "Linear Programming in Single and Multiple-objective Systems", Prentice- Hall Inc., Englewood Cliffs, New Jersey, 1982.
- [9] J.G. Ndiritu, T.M. Daniell, "An improved genetic algorithm for continuous and mixed discrete-continuous

optimization”, Engineering Optimization, 31, pp. 589-614, 1999.

[10] J.A. Nelder, R. Mead, “A simplex method for function minimization”, Computer Journal, 7, pp. 308-313, 1965.

[11] J.L. Marcelin, “Evolutionary optimization of mechanical structures”, Engineering Optimization, 31, 571-588, 1999.

[12] M.K. Rahman, “An intelligent moving object optimization algorithm for design problems with mixed variables, mixed constraints and multiple objectives”, Structural and Multidisciplinary Optimization, 32, pp. 40-58, 2006.

[13] T.K. Parkins, L.R. Kern, “Widths of hydraulic fractures”, J. of Petroleum Technology, September, pp. 937-949, 1961.

[14] R.P. Nordgren, “Propagation of a vertical hydraulic fracture”, Society of Petroleum Engineers J., August, pp. 306-314, 1972.

[15] G.C. Howard, C.R. Fast, “Optimum fluid characteristics for fracture extension”, Drilling and Production Practices, API (Appendix by E.D. Carter: derivation of the general equation for estimating the extent of the fractured area), pp. 261-270, 1957.

[16] N. R. Warpinski and M.B. Smith, “Rock Mechanics and fracture geometry”, In: Recent Advances in Hydraulic Fracturing, Monograph Vol. 2, Gidley, J.L. et al. (Eds.). Richardson, TX : SPE, 1989.

[17] Y. Gao, “Modeling of Transient Pressure Behaviors for Transversely Fractured Horizontal Well in Naturally Fractured Reservoir”, M.Sc. Thesis, Khalifa University of Science and Technology, 2018.

[18] D. Biswas, “Shale Gas Predictive Model (SGPM) – An Alternate approach to predict shale gas production”, SPE 148491 Eastern Regional Meeting, Columbus, Ohio, USA, 17-19 August, 2011.

[19] N. Li, Q. Ran, J. Li, J. Yuan, C. Wang, Y. Wu, “A Multiple-Continuum Model for Simulation of Gas production from Shale Gas Reservoirs”, SPE 165991 Reservoir Characterisation and Simulation Conference and Exhibition, Abu Dhabi, UAE, 16-18 September, 2013.

[20] O.A. Adefidipe, H. Dehghanpour, C.J. Virues, “Immediate gas production from shale gas Wells: A Two-phase Flowback Model”, SPE 168982 Unconventional Resources Conference, The Woodlands, TX, USA, 1-3 April, 2014.

[21] J. C. Pashin, G. Jin, C. Zheng, S. Chen, M. R. McIntyre, "Discrete Fracture Network Models of the Secarb Carbon Sequestration Test Site, Deerlick Creek Field, Black Warrior Basin, Alabama". Paper 0821, International

Coalbed & Shale Gas Symposium, Tuscaloosa, Alabama, 2008.

[22] A. Suboyin, “Hydraulic Fracture Propagation in the Presence of Natural Fractures in Shale Gas Reservoirs”, M.Sc. Thesis, Khalifa University of Science and Technology, 2018.

[23] A. Suboyin, M.M. Rahman, M. Haroun, A. Shaik, “A Novel Dynamic Assessment of Multi-Stage Hydraulic Fracture Propagation in Presence of Natural Fractures in Shale Gas Reservoirs”, SPE192811 Abu Dhabi International Petroleum Exhibition and Conference, 12-15 November, Abu Dhabi, UAE, 2018.

Table 1. Free design variables and their bound values

Variable name (unit)	Variable symbol	Bound values
Injection rate (bbl/min)	q_i	10-40
Injection time (min)	t_i	30-200
EOJ Proppant concentration	P_c	15
Fracturing fluid viscosity (cp)	μ	100-300

Table 2. Tight Gas formation, geomechanical and wellbore data [1]

Parameters	Value
Drainage area (square)	640 acres
Average depth	7,500 ft
Thickness	100 ft
Porosity	10%
Permeability	0.20 md
Reservoir pressure &	4,400 psi, 200 F
Gas saturation	0.8
Water compressibility	$3.0E-6 \text{ psi}^{-1}$
Pore compressibility	$8.6E-6 \text{ psi}^{-1}$
Max. horizontal stress	7,000 psi
Min. horizontal stress (close)	6,000 psi
Min. horizontal stress	6.700 psi
Young's modulus	5.075E-6
Poisson's ratio	0.20
Leakoff coefficient	$0.00025 \text{ ft/min}^{0.5}$
Wellbore radius	0.35 ft

Flowing bottomhole	1,700 psi
Tubing inside diameter	2.992 inch
Rated pressure for	14,000 psi

Table 3. Ultra-tight Shale Gas formation and Geomechanical data [22, 23]

Parameters	Value
Drainage area (square shape)	120 acres
Average depth	11,000 ft
Thickness	283 ft
Porosity	4%
Permeability	0.5 micro-Darcy
Reservoir pressure & temperature	7,000 psi, 285 F
Wellbore Lateral length	3700 ft
Number of fracture stages	10
Fracture spacing	100 ft
Gas saturation and specific gravity	0.8 and 0.621
Reservoir gas viscosity	0.02 cp
Vertical stress	65 MPa
Max. horizontal stress	45 MPa
Min. horizontal stress	35 MPa
Young's modulus	30 GPa
Poisson's ratio	0.20
Tensile strength	4 MPa
Rock compressibility	33/GPa
Flowing bottomhole pressure	3,600 psi

Table 4. Initial Design and Optimum design for three different objective functions [1]

Variable symbol	Initial Design	Design 1	Design 2	Design 3
q_i (bbl/min)	30	24	24	15
t_i (min)	67	134	134	82.5
P_c (ppg)	7	15	15	14.5
μ (cp)	210	99.7	99.8	89.3

x_f (ft)	550	2,500	2,498	1,581
NPV (m\$)	11.423	16.530	16.52	14.749
G_p (bscf)	18.357	26.294	26.29	23.110
C_{tr} (m\$)	0.5757	1.000	0.998	0.551

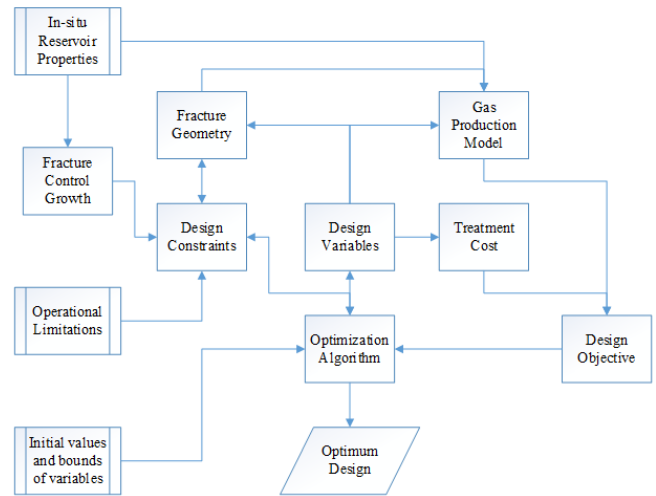

Figure 1. Integrated model of hydraulic fracture optimization

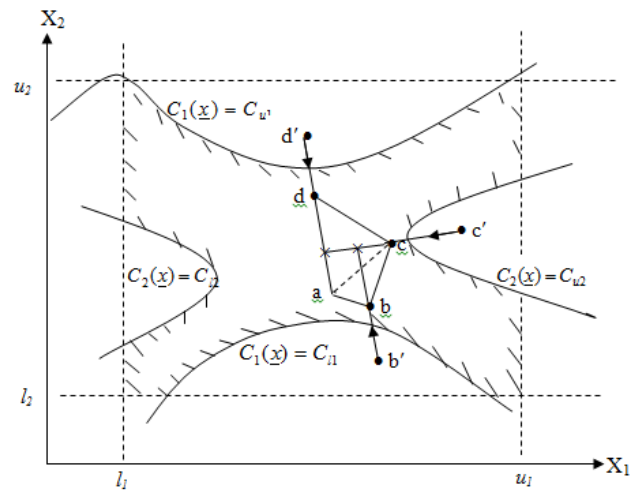

Figure 2. Generation of the initial compound with four vertices [1]

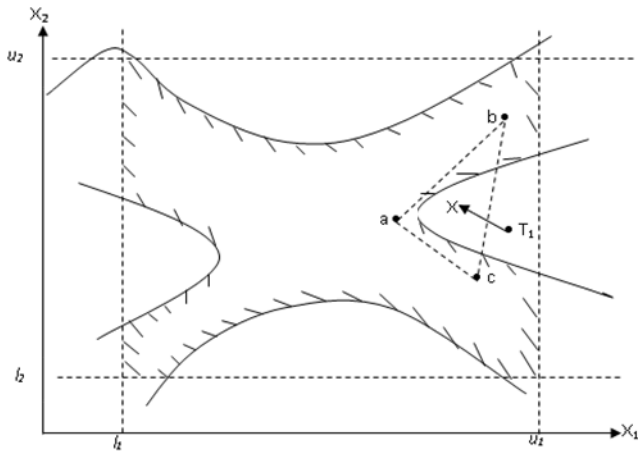

Figure 3. A compound with four vertices 'a, b, c, d' cannot be generated [1]

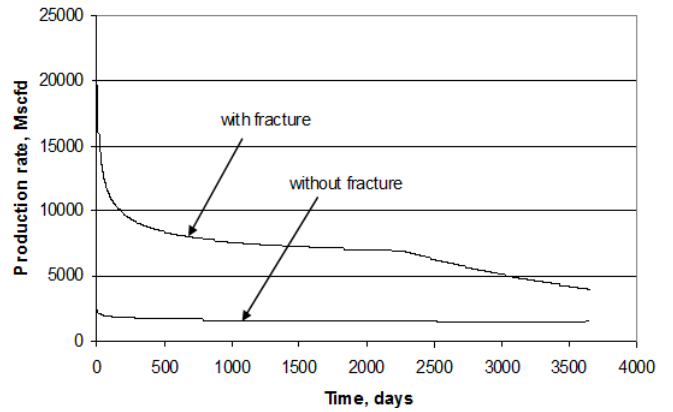

Figure 6. Benefits of optimum hydraulic fracture treatment

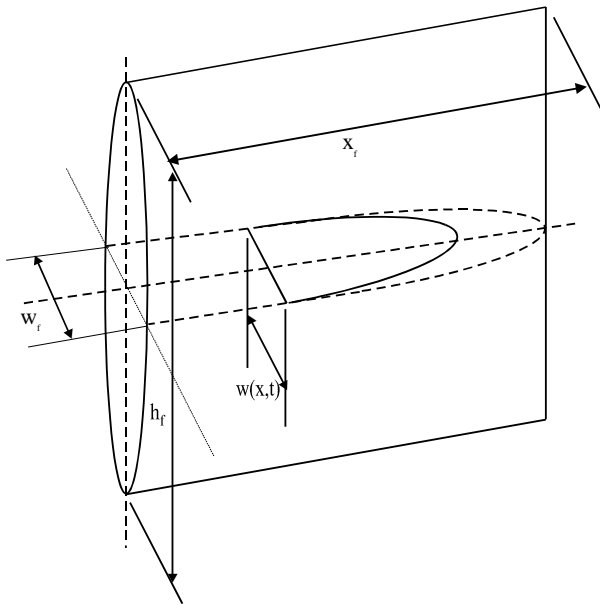

Figure 4. The PKN fracture model [13, 14]

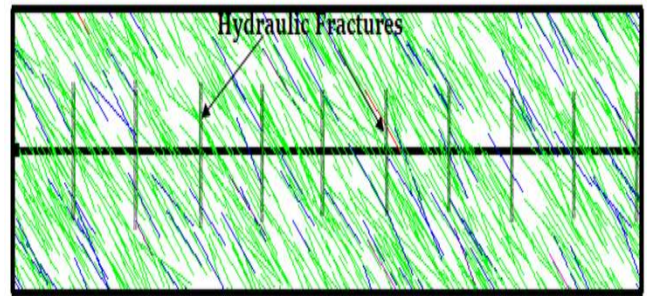

Figure 7. A horizontal well fractured transversely in 10 stages: a simplistic model [22, 23]

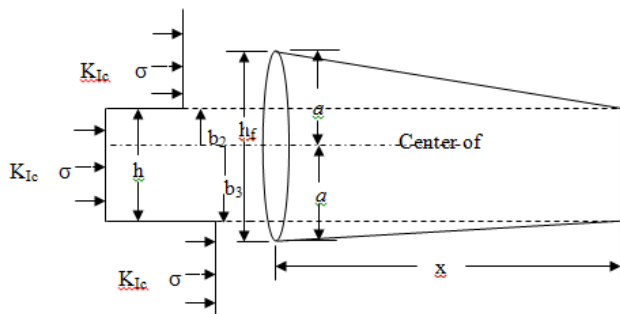

Figure 5. The P-3D fracture model: fracture in a layered stress medium [16]

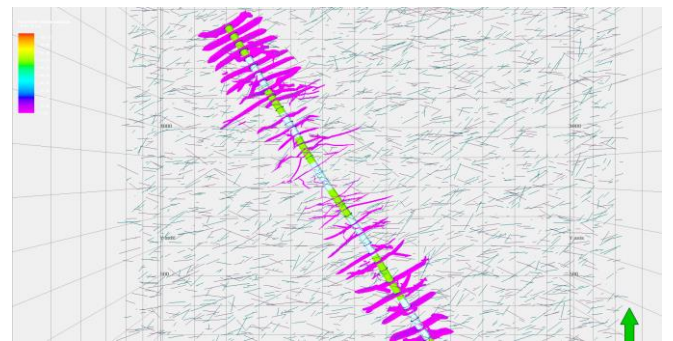
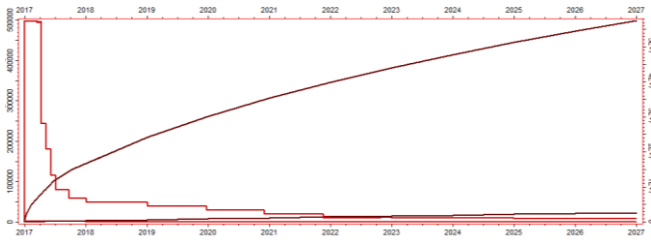

Figure 8. Simplistic representation of constructed realistic model [22, 23]



	Daily (Initial)	Cumulative
With Fractures	5 MMSCF/Day	5 BSCF
Without Fractures	~0	~ Less than 0.05%

Figure 9. Fracture versus No fracture – Shale gas production

